



يارا مهر بنديان

ارائه کننده ابزار و ست های جراحی

کاتالوگ اورتوپدی

تلفن : ۰۲۱-۶۶۹۵۱۰۰۰

www.yaramehr.com

 Yaramehr.firm

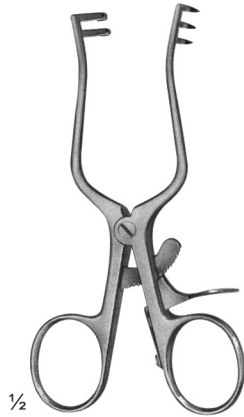

SF-04-101
WEITLANER
Sharp
110 mm

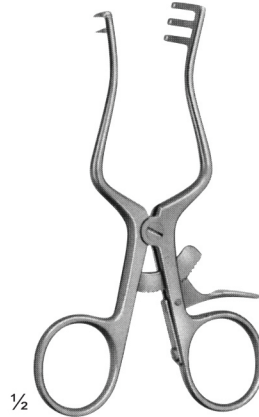

SF-04-102
WEITLANER
Semi-Sharp
110 mm



SF-04-103
WEITLANER
Blunt
110 mm



SF-04-104
WEITLANER
Sharp
130 mm

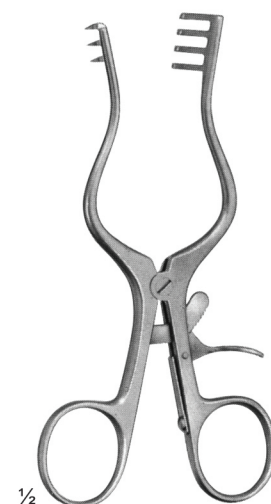

SF-04-105
WEITLANER
Semi-Sharp
130 mm

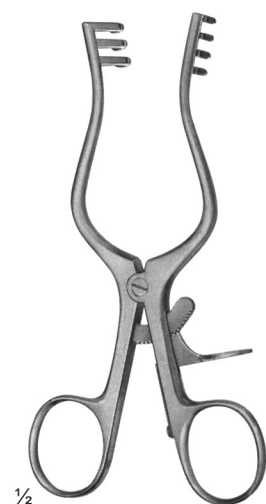

SF-04-106
WEITLANER
Blunt
130 mm

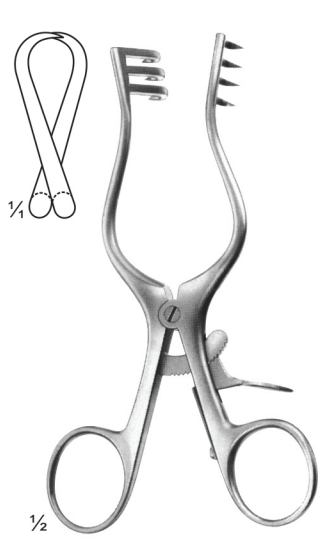

SF-04-107
WEITLANER
Sharp
130 mm

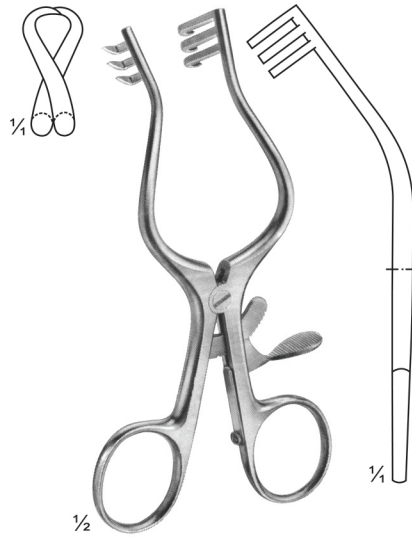

SF-04-108
WULLSTEIN
Sharp
130 mm

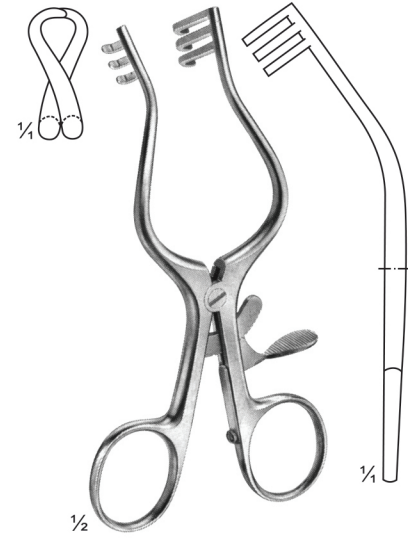

SF-04-109
WULLSTEIN
Blunt
130 mm

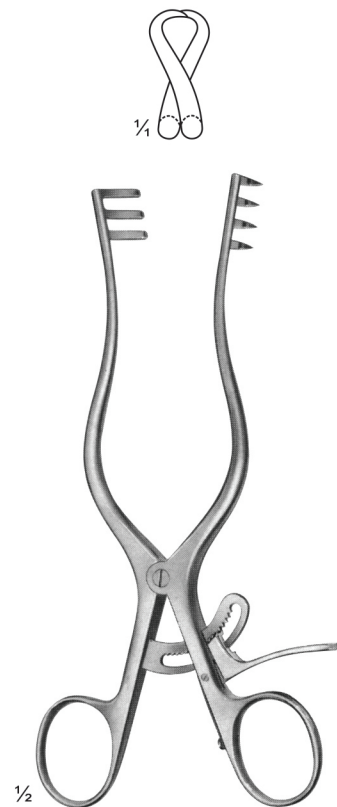

SF-04-110
WEITLANER
Sharp
165 mm



SF-04-111
PLESTER
Blunt
110 mm

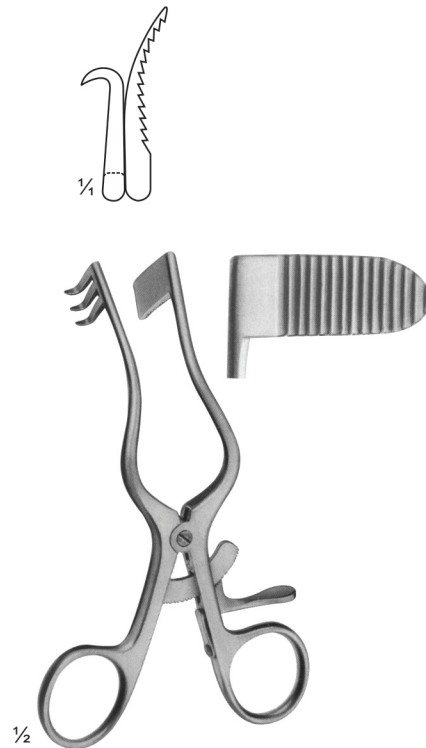

SF-04-112
PERKINS
130 mm

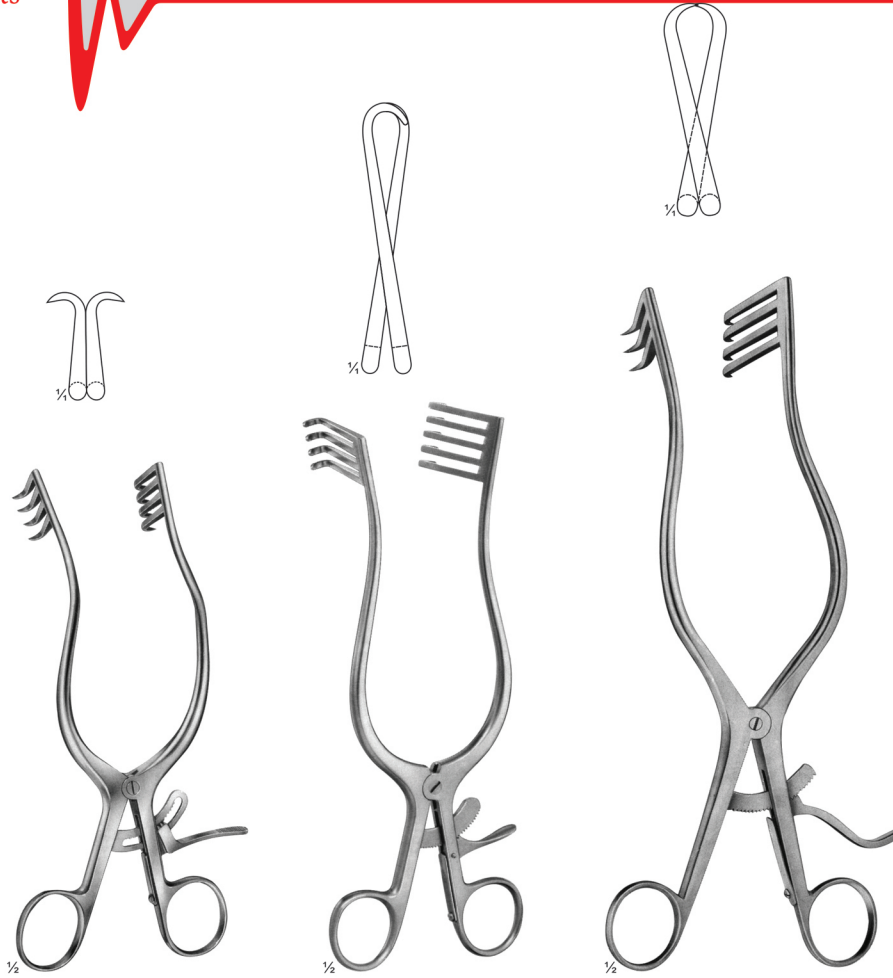

SF-04-116
ANDERSON-ADSON
Sharp
190 mm

SF-04-117
NORFOLK and
NORWICH
Blunt
220 mm

SF-04-118
ADSON
Sharp
265 mm

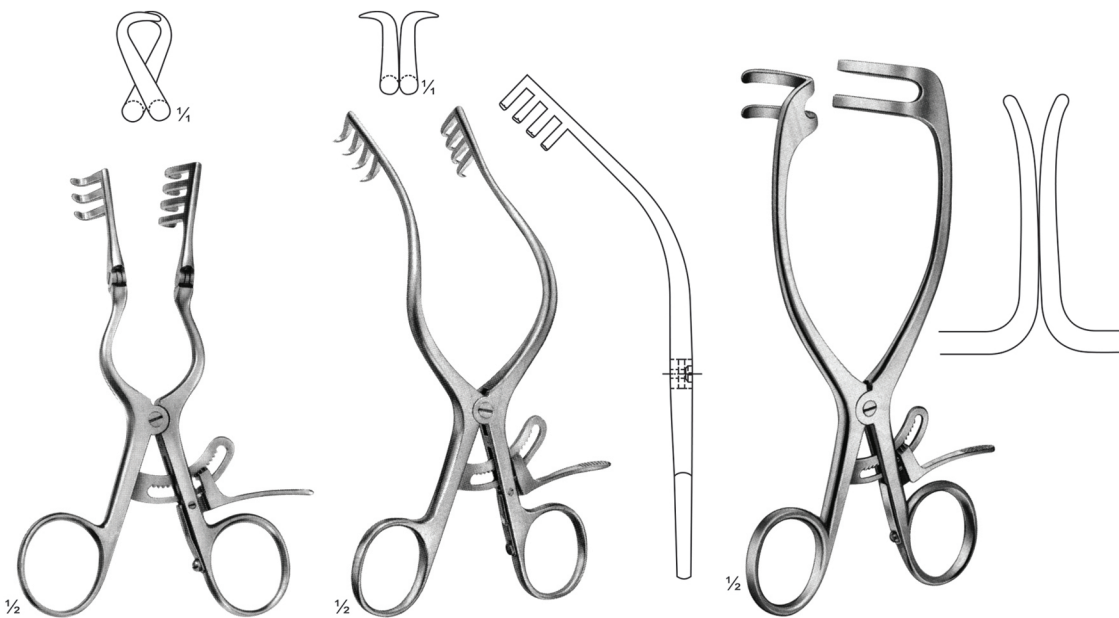

SF-04-113
ADSON-BABY
Blunt
140 mm

SF-04-114
MOLLISON
Sharp
155 mm

SF-04-115
MAYO-ADAMS
165 mm

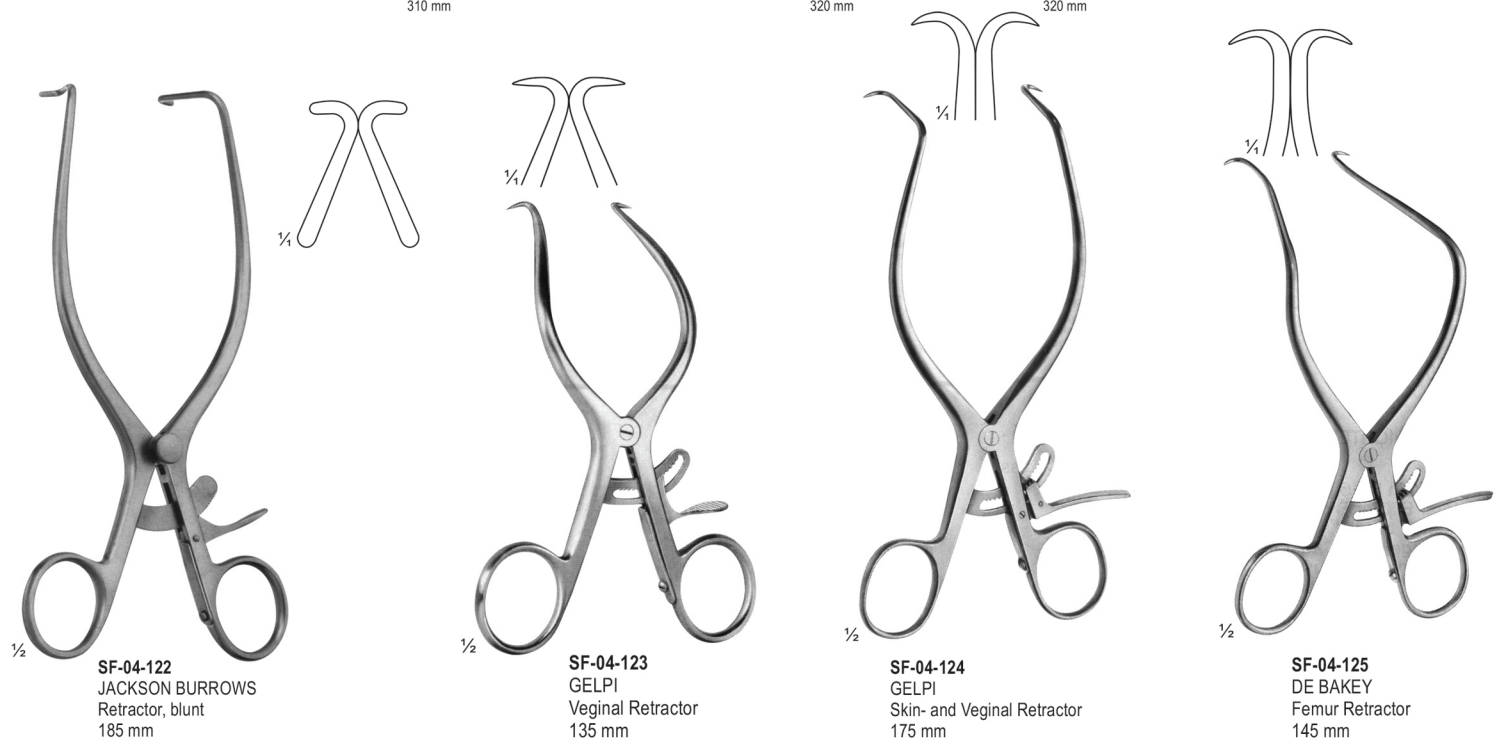
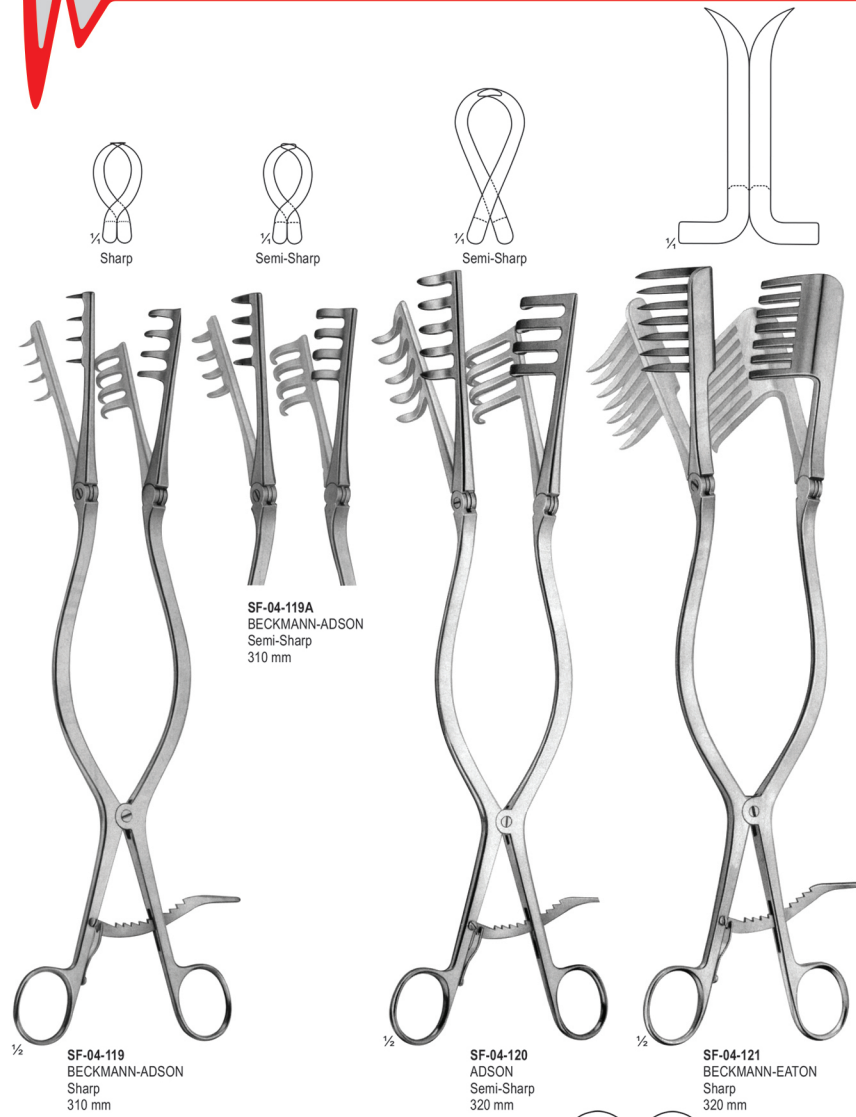

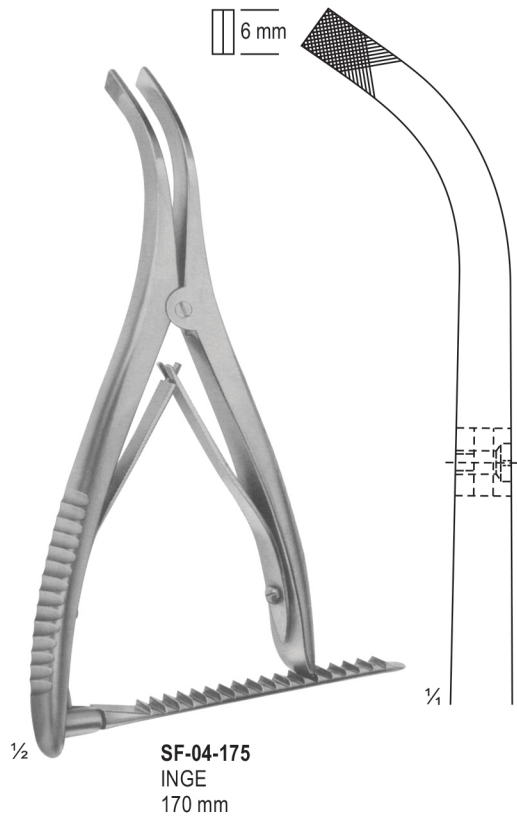
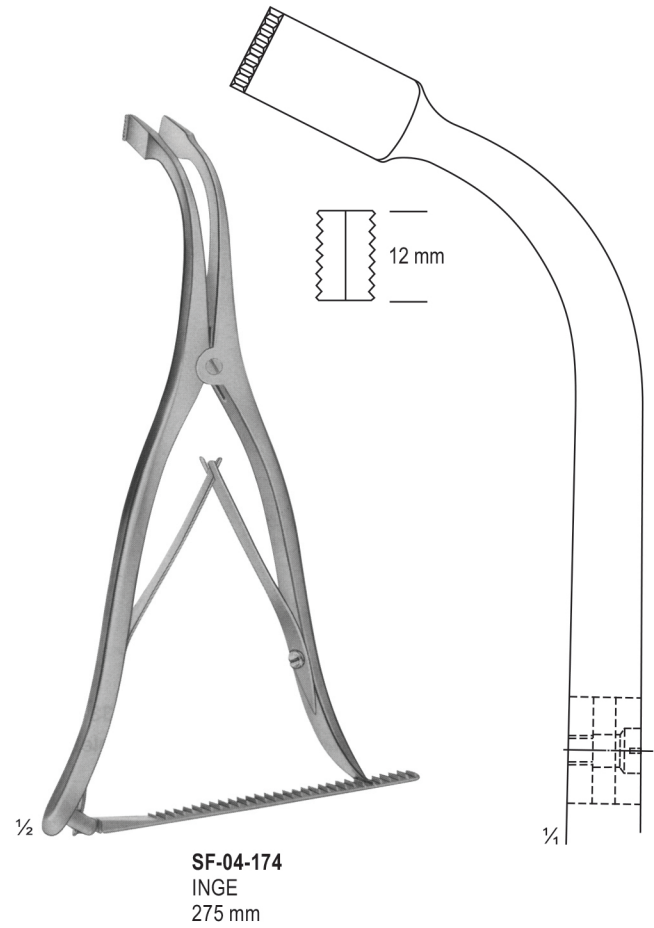
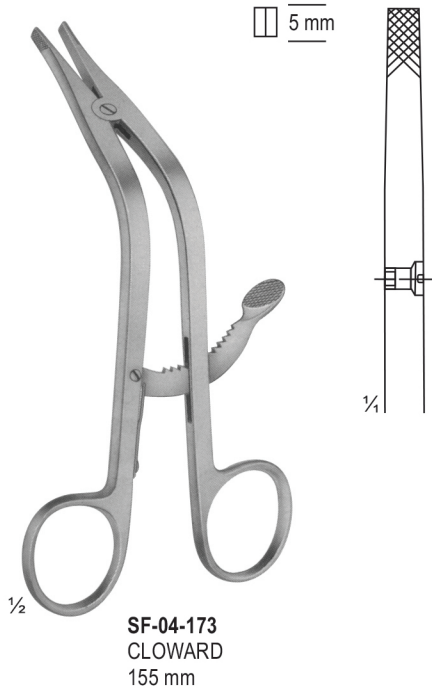



SF-10-296 - 205
200 mm - 8"



FOMON
Teeth

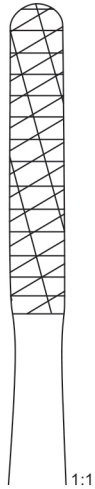

SF-10-296
Fig.1
12

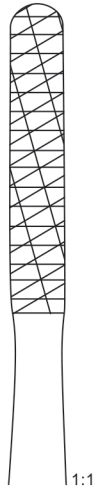

SF-10-297
Fig.3
16

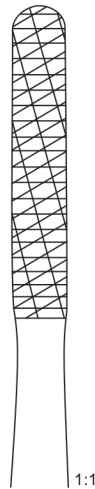

SF-10-298
Fig.5
24

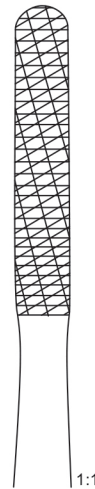

SF-10-299
Fig.7
36

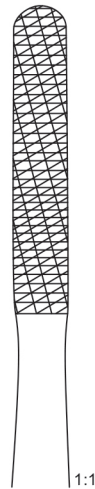

SF-10-300
Fig.9
52



FOMON TC
Teeth



SF-10-301
Fig.2
14



SF-10-302
Fig.4
20



SF-10-303
Fig.6
30

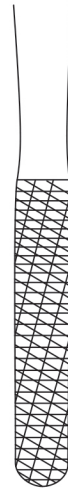

SF-10-304
Fig.8
44

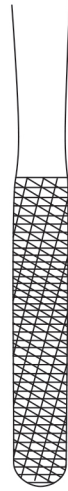

SF-10-305
Fig.10
62

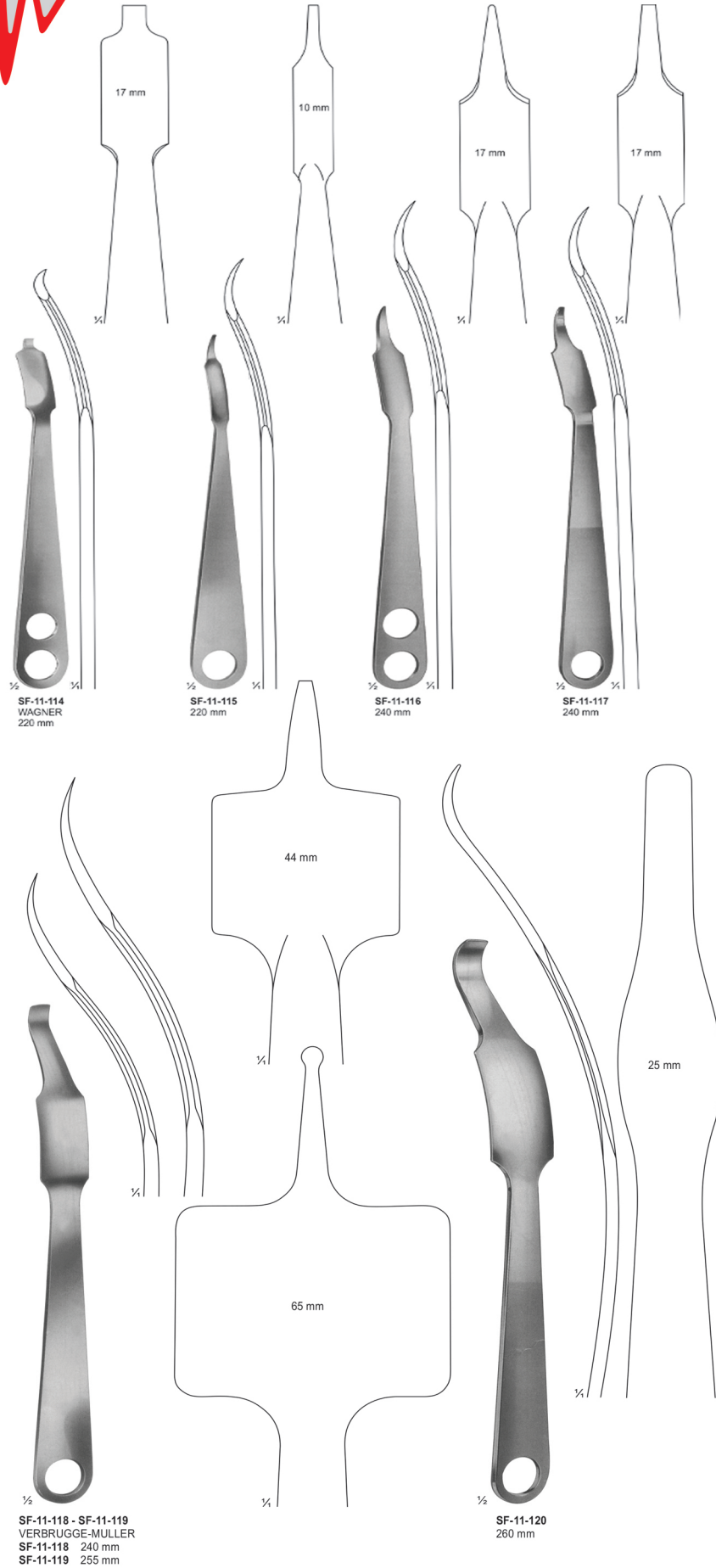



SF-11-256
3.6 mm
Fig: 000



SF-11-257
4.4 mm
Fig: 00



SF-11-258
5.2 mm
Fig: 0



SF-11-259
6.8 mm
Fig: 1



SF-11-256 - SF-11-259
250 mm



SF-11-260
3.6 mm
Fig: 000



SF-11-261
4.4 mm
Fig: 00



SF-11-262
5.2 mm
Fig: 0



SF-11-263
6.8 mm
Fig: 1



SF-11-260 - SF-11-263
250 mm



SF-11-264
3 mm



SF-11-265
4 mm



SF-11-266
5 mm



SF-11-264 - SF-11-266
BUSHE
250 mm



SF-14-138 - SF-14-145
Large curve,
sharp
165 mm



SF-14-138



SF-14-139



SF-14-140



SF-14-141



SF-14-142



SF-14-143



SF-14-144



SF-14-145



SF-14-146 - SF-14-153
Large curve,
blunt
165 mm



SF-14-146



SF-14-147



SF-14-148



SF-14-149



SF-14-150



SF-14-151



SF-14-152



SF-14-153

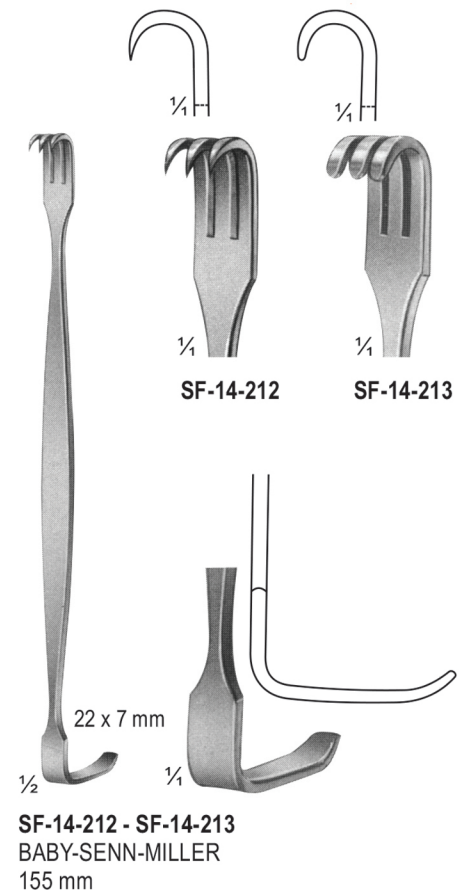
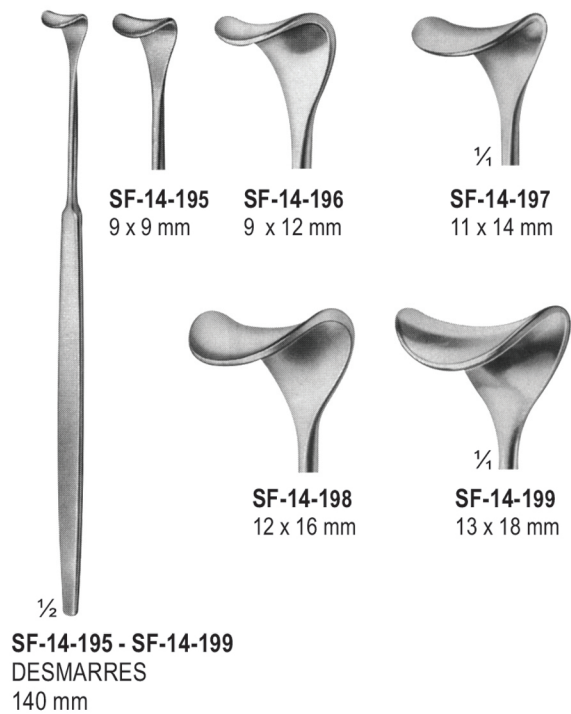
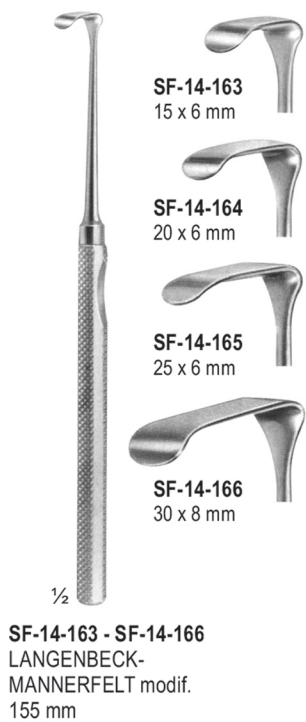
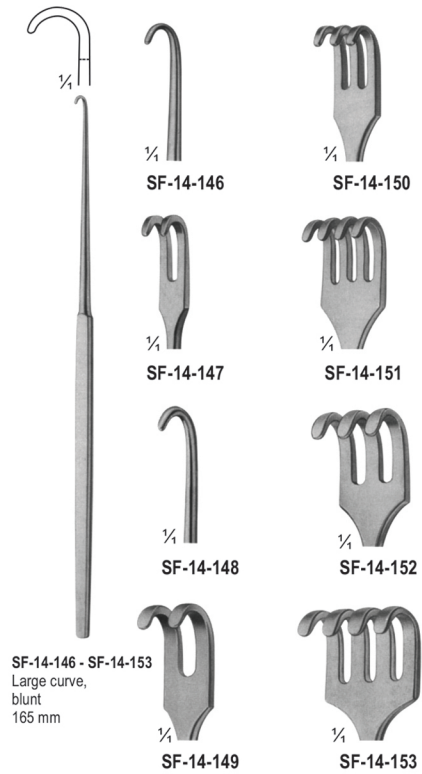
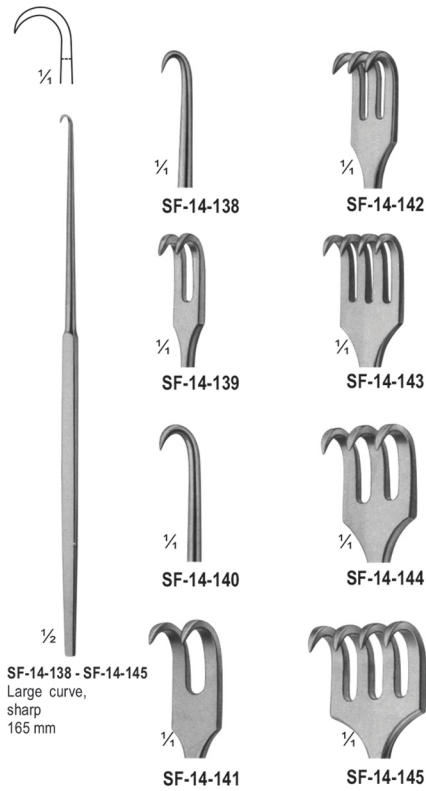

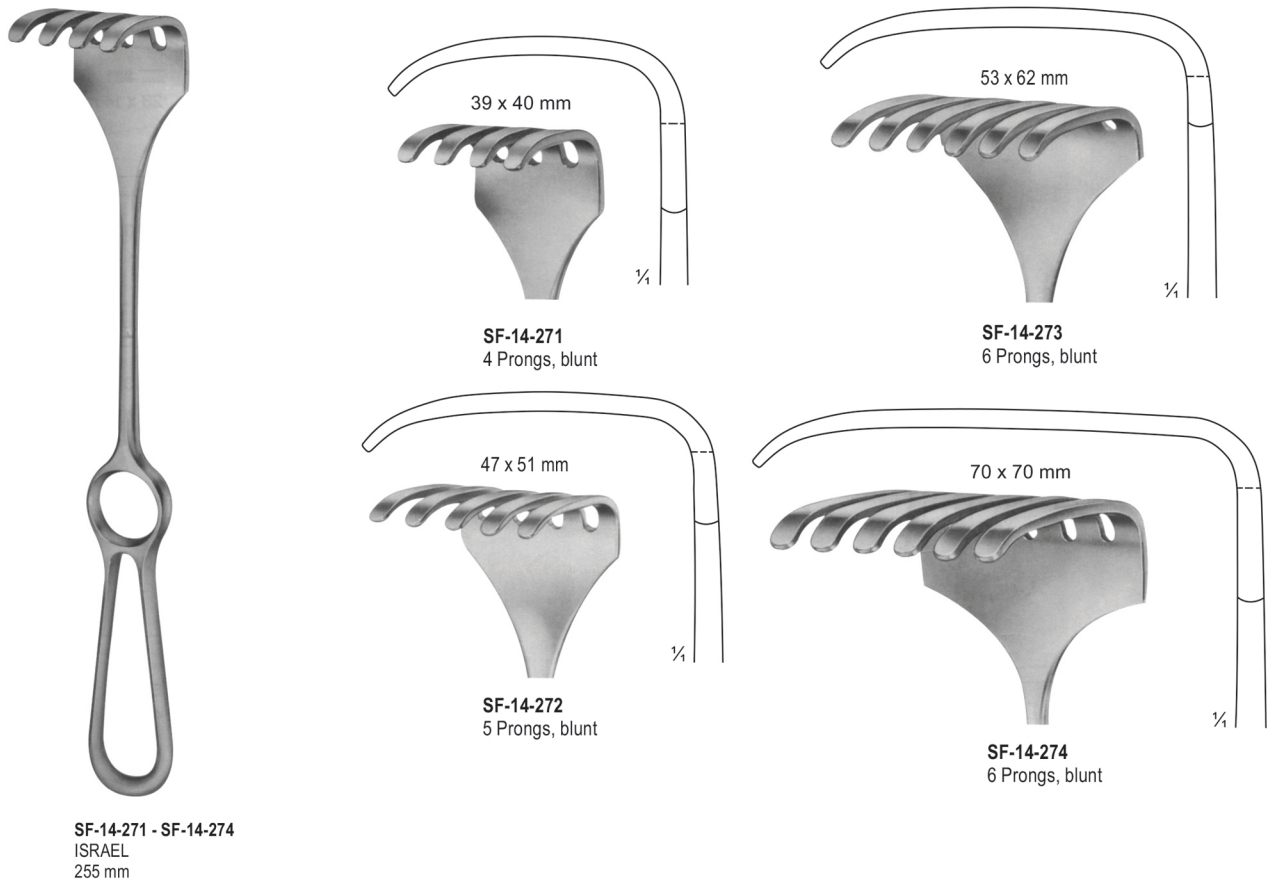
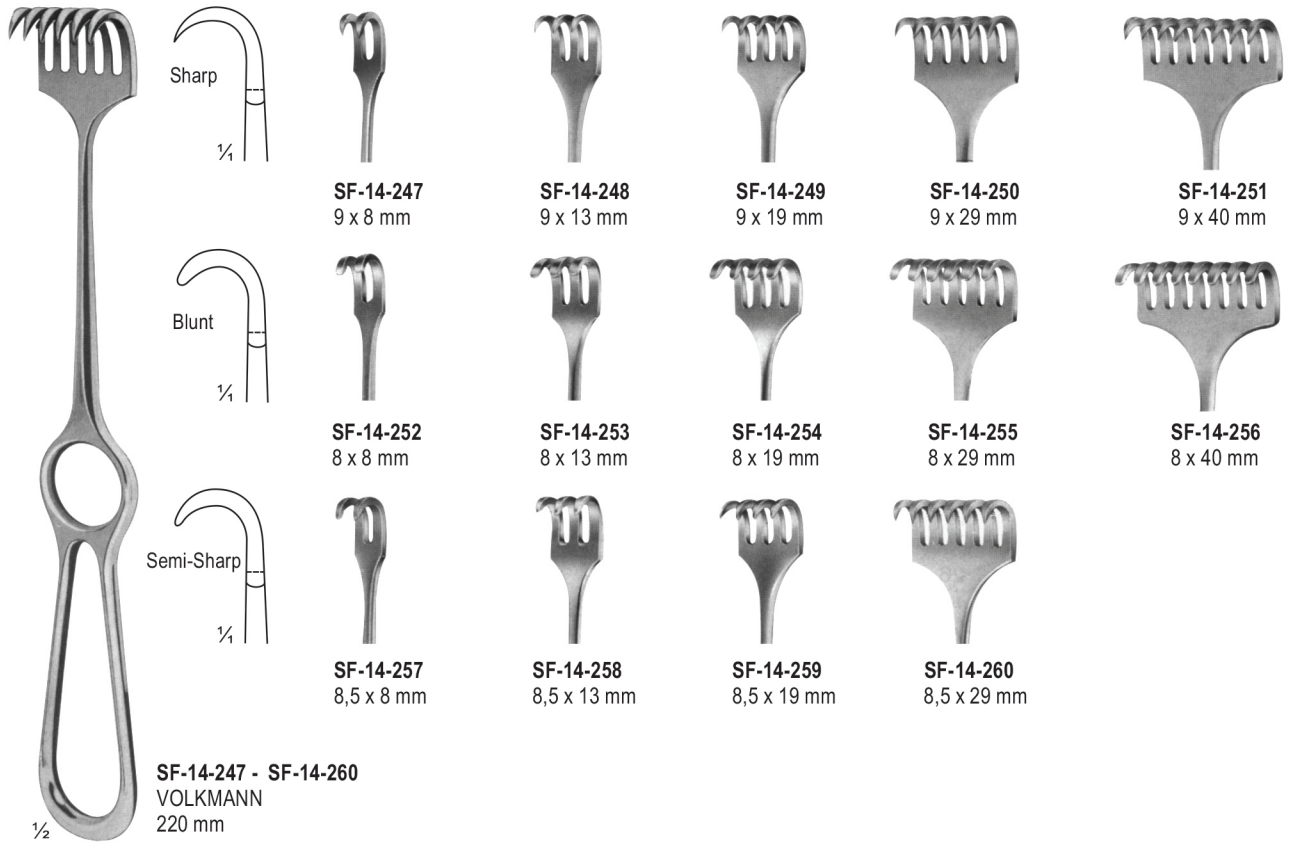

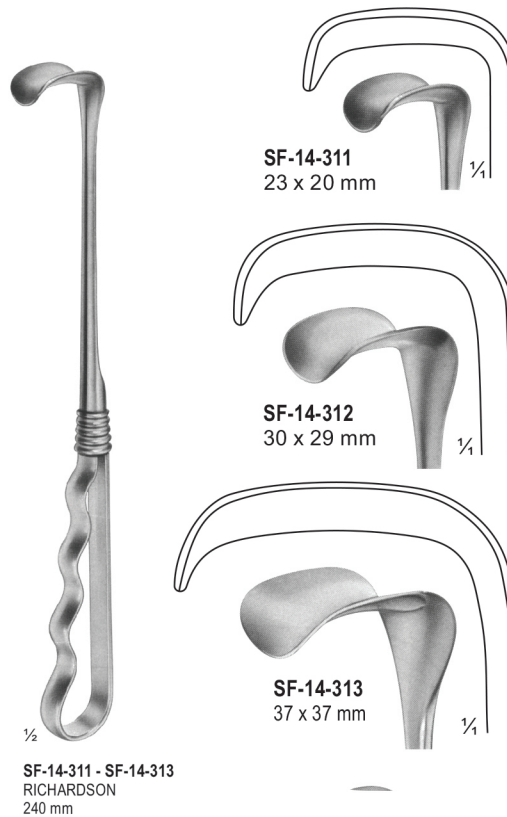

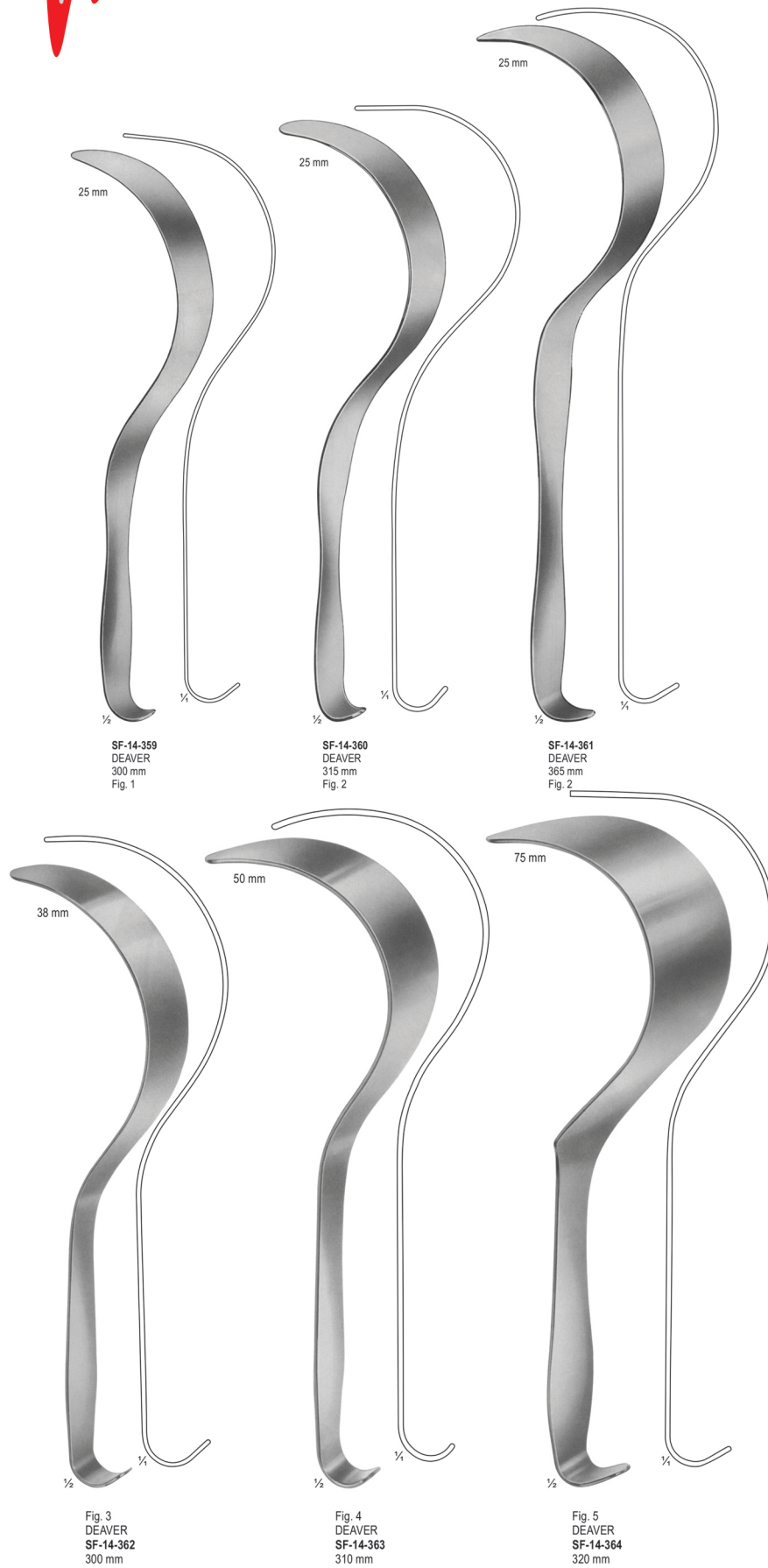

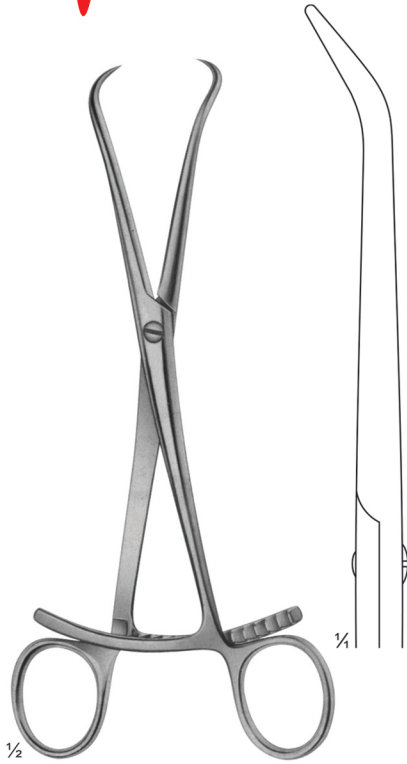

Repositioning forceps
SF-19-116
205 mm



LEWIN
SF-19-118



SETTER
SF-19-123
170 mm



SETTER
SF-19-124
235 mm

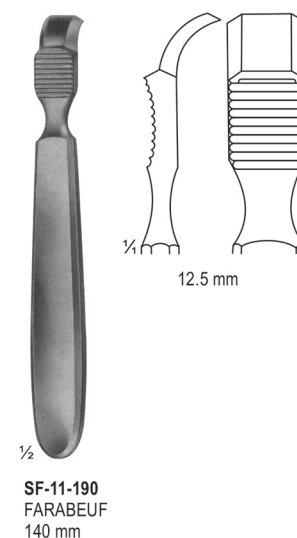
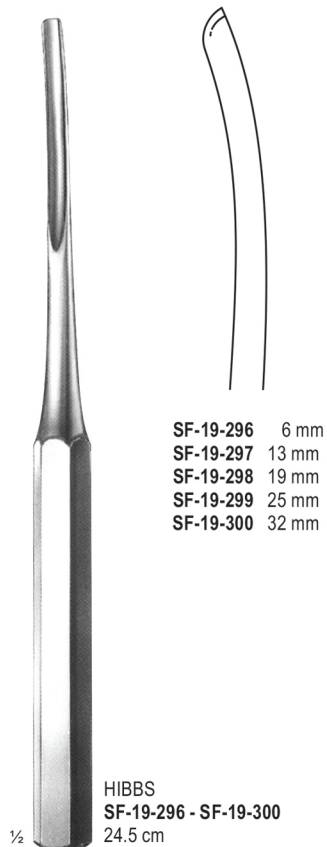
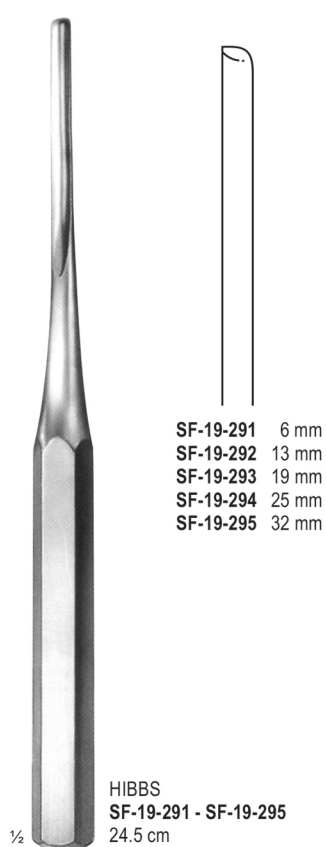
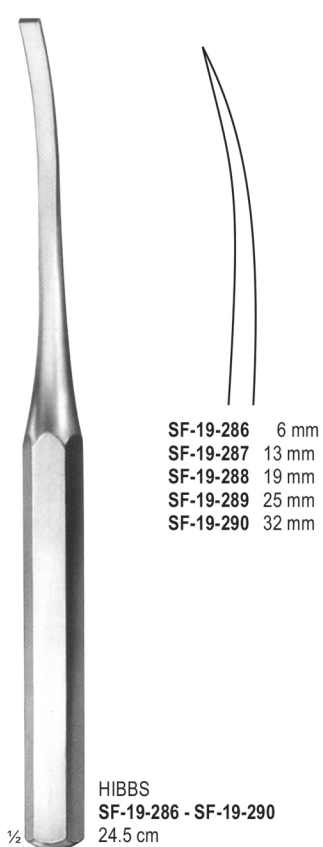
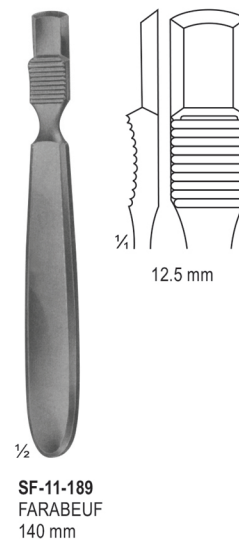
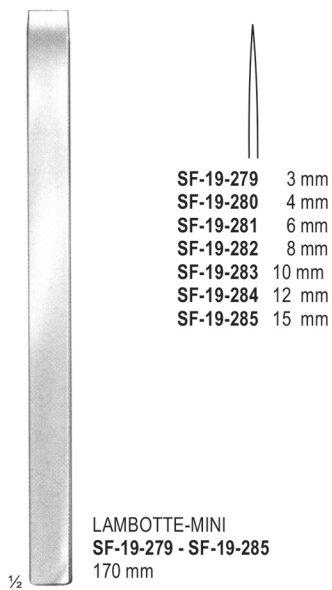
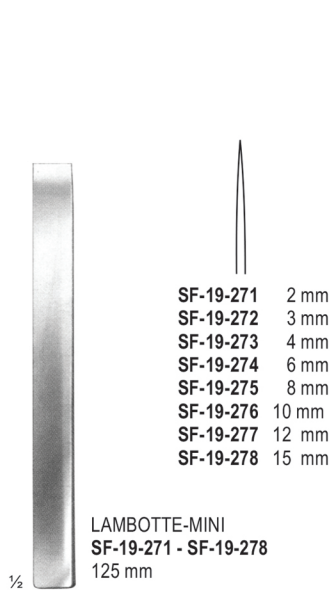

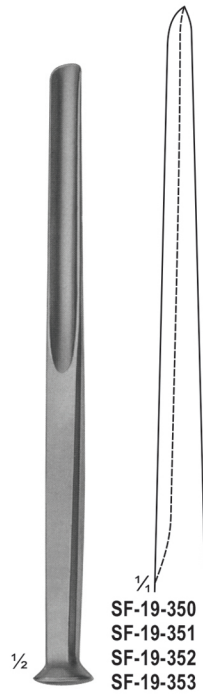

SF-19-350 5 mm
SF-19-351 7 mm
SF-19-352 9 mm
SF-19-353 11 mm

ALEXANDER
SF-19-350 - SF-19-353
Gouges
170 mm



SF-19-354 4 mm
SF-19-355 6 mm
SF-19-356 8 mm
SF-19-357 10 mm
SF-19-358 12 mm
SF-19-359 15 mm

LAMBOTTE
SF-19-354 - SF-19-359
Osteotome
125 mm



SF-19-360 4 mm
SF-19-361 6 mm
SF-19-362 8 mm
SF-19-363 10 mm
SF-19-364 12 mm

COTTLE
SF-19-360 - SF-19-364
Osteotome with depth
markings
180 mm



SF-19-365 4 mm
SF-19-366 7 mm
SF-19-367 9 mm
SF-19-368 12 mm

COTTLE
SF-19-365 - SF-19-368
Chisel-Osteotomes
with depth markings
180 mm



COTTLE
SF-19-369
Fishtail Chisel,
with protected ends
180 mm

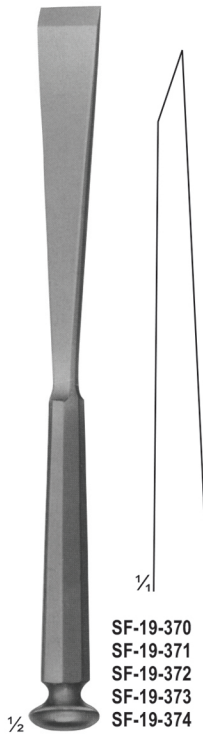

SF-19-370 10 mm
SF-19-371 12 mm
SF-19-372 15 mm
SF-19-373 20 mm
SF-19-374 25 mm

STILLE
SF-19-370 - SF-19-374
Chisels
205 mm

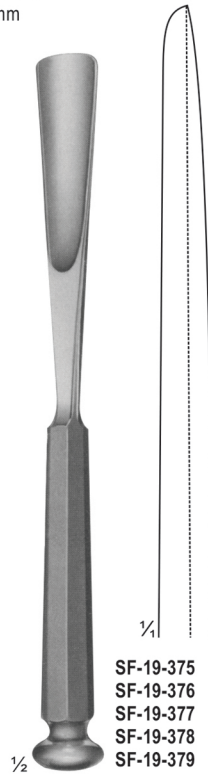

SF-19-375 10 mm
SF-19-376 12 mm
SF-19-377 15 mm
SF-19-378 20 mm
SF-19-379 25 mm

STILLE
SF-19-375 - SF-19-379
Gouges
205 mm

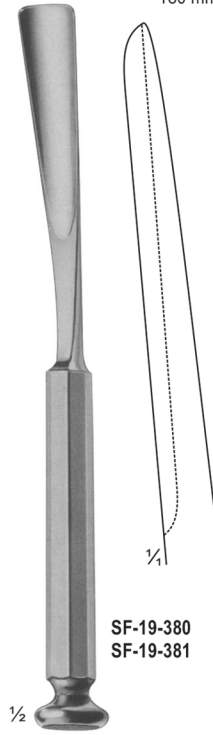

SF-19-380 10 mm
SF-19-381 15 mm

WALTER
SF-19-380 - SF-19-381
Osteotomes
gouges for taking
grafts from the rib
205 mm

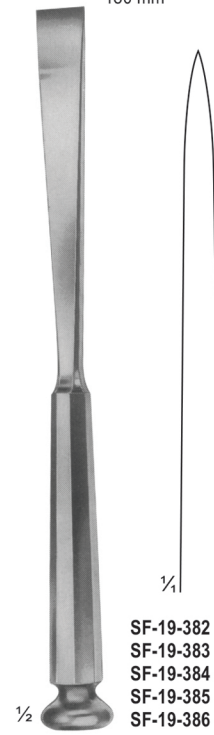

SF-19-382 8 mm
SF-19-383 12 mm
SF-19-384 15 mm
SF-19-385 20 mm
SF-19-386 25 mm

STILLE
SF-19-382 - SF-19-386
Osteotomes
205 mm

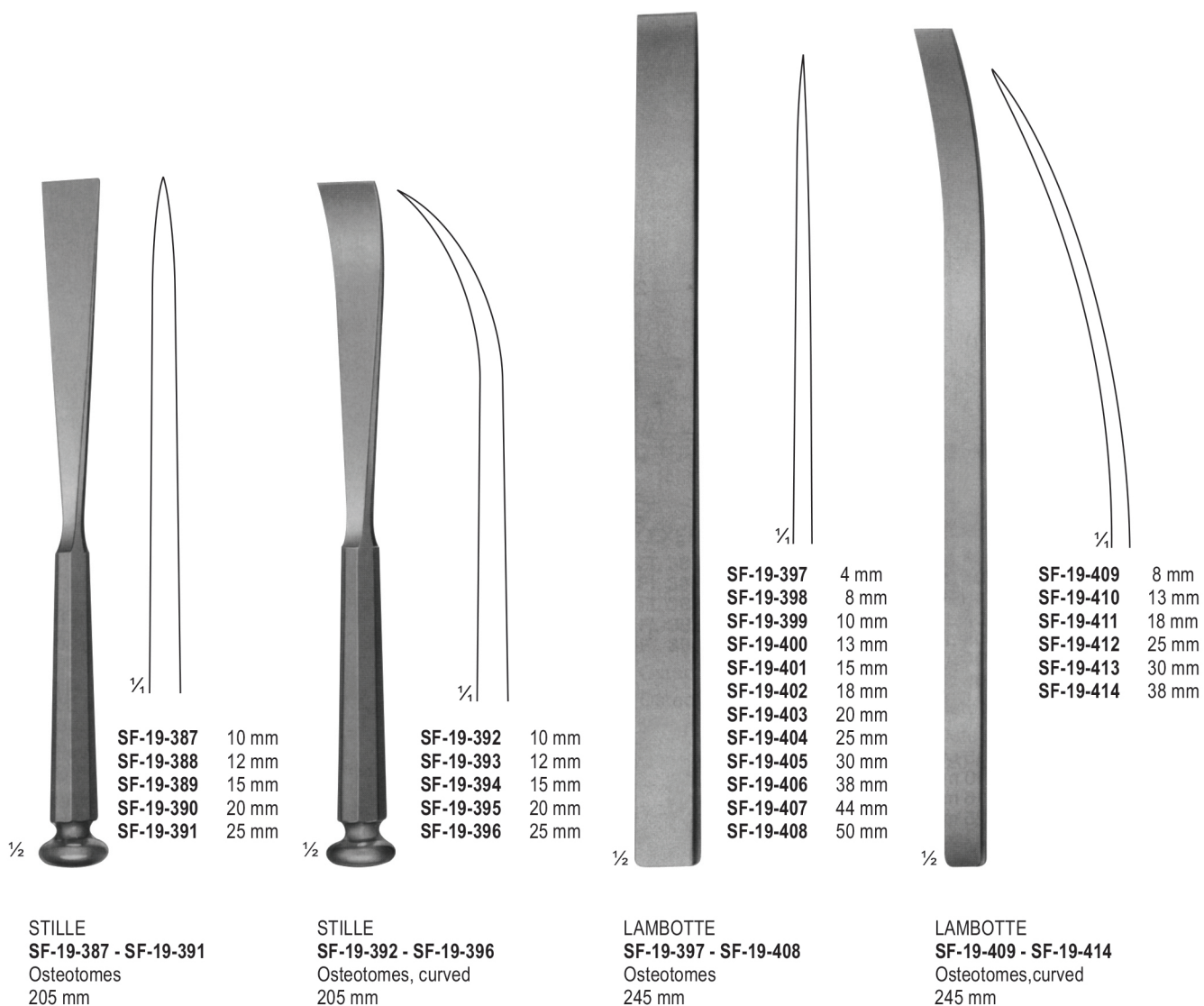

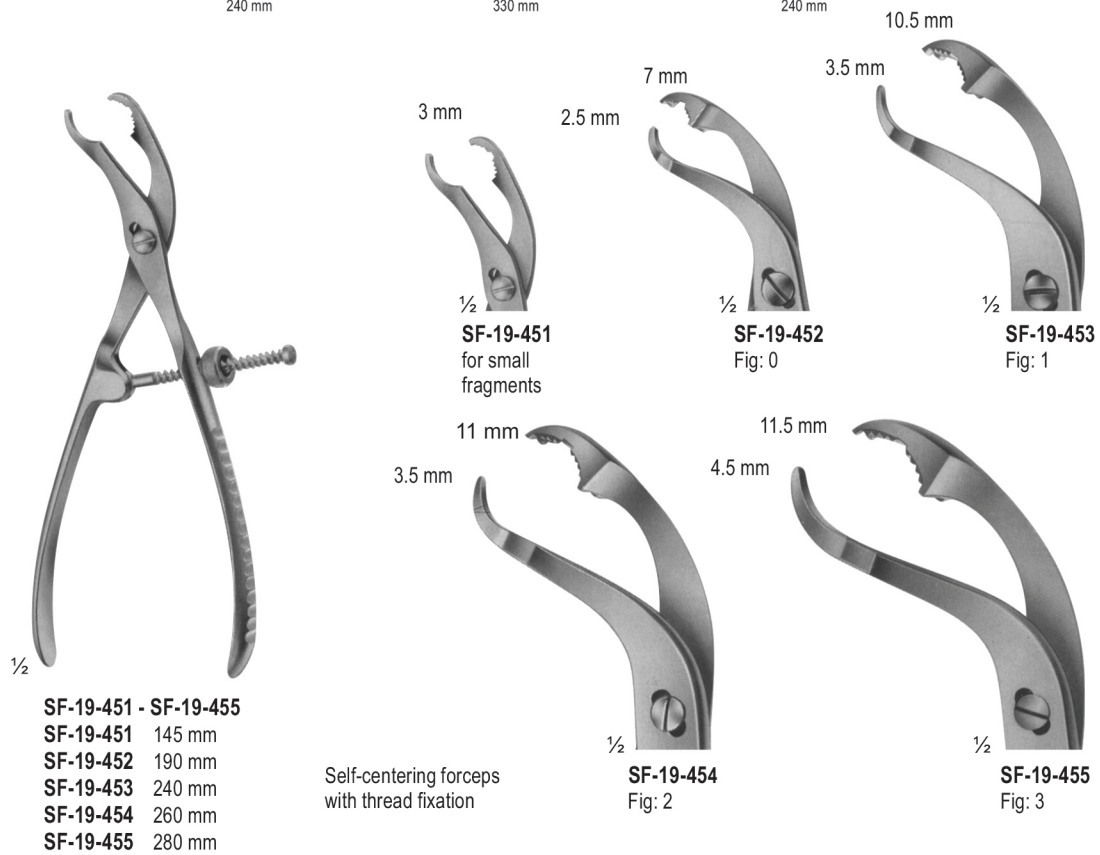
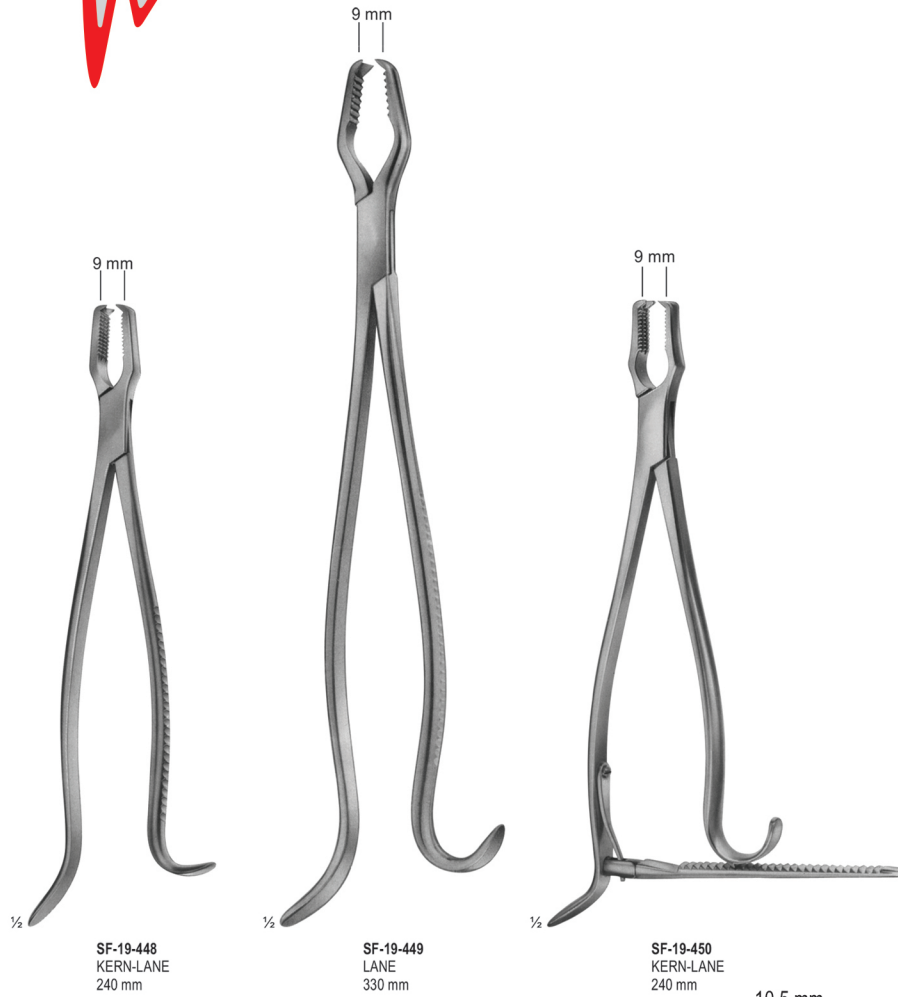



SF-19-460 - SF-19-461
LOWMAN
SF-19-460 170 mm
SF-19-461 205 mm

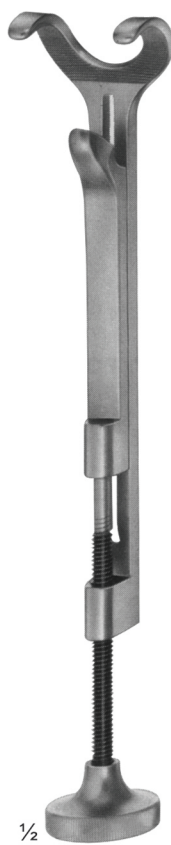

SF-19-462
LOWMAN-GERSTER
210 mm



SF-19-463
LOWMAN-HOGLUND
175 mm

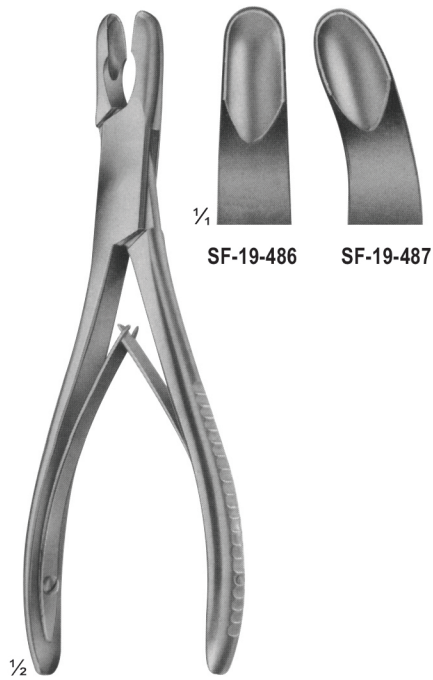

SF-19-486 - SF-19-487
LURE
175 mm

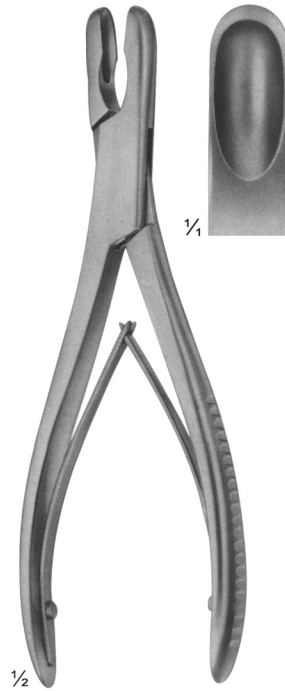

SF-19-488
LURE
180 mm

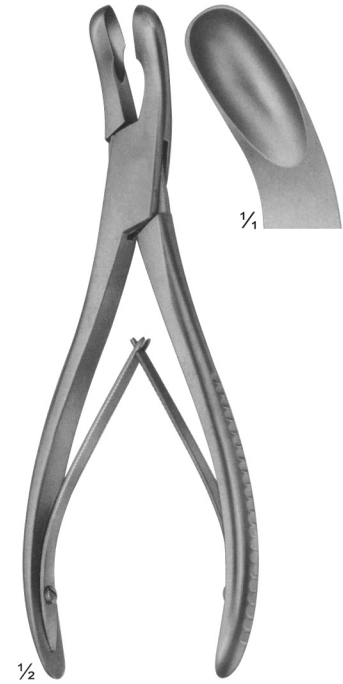

SF-19-499
LURE
180 mm

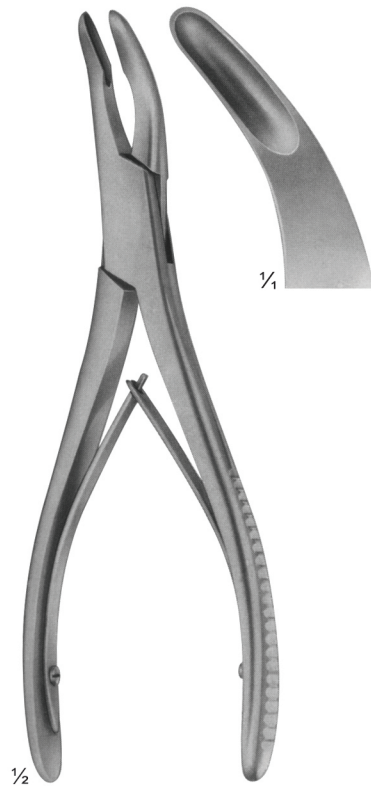

SF-19-490
OLIVECRONA
205 mm



SF-19-491 - SF-19-492
BOHLER
155 mm

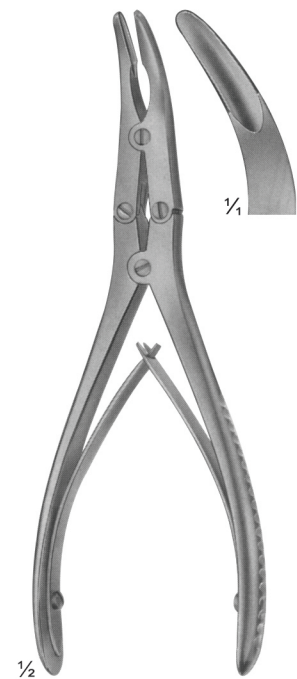

SF-19-493
MARQUARTD
200 mm

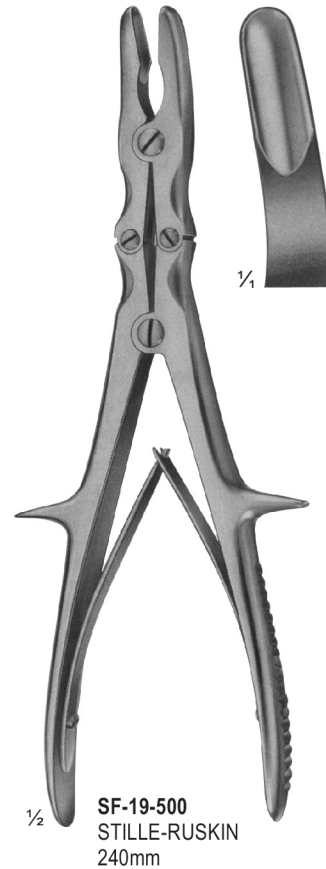
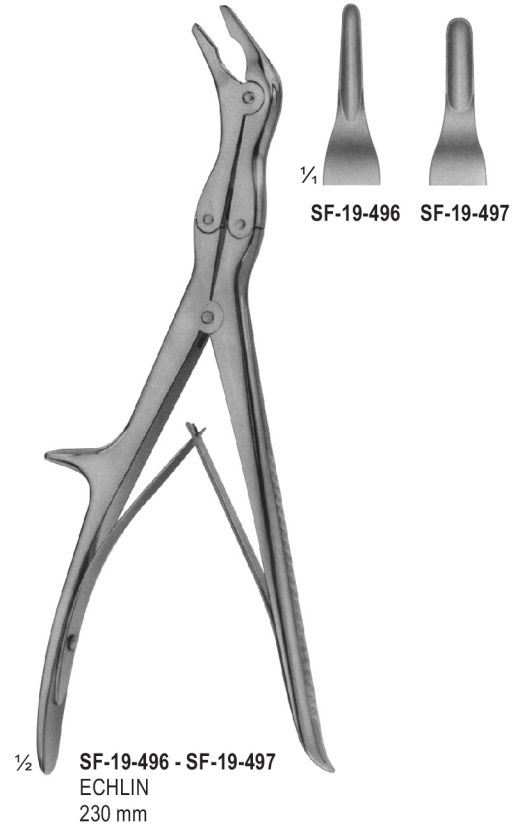
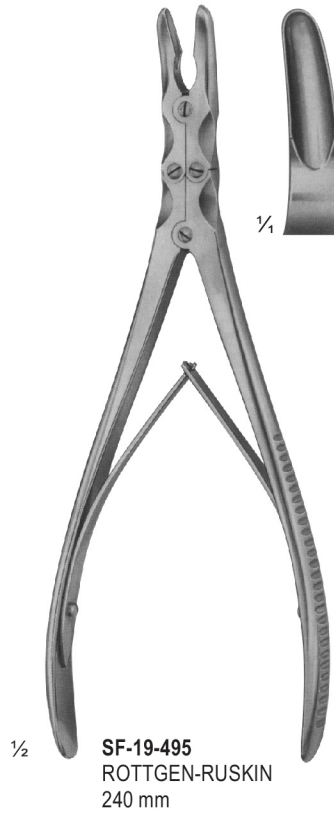

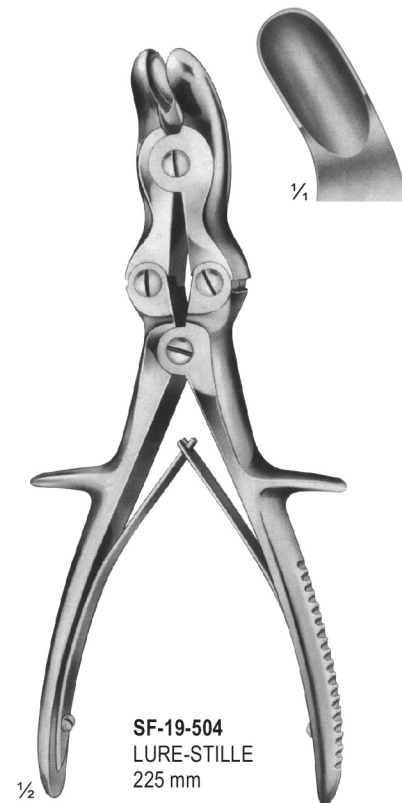
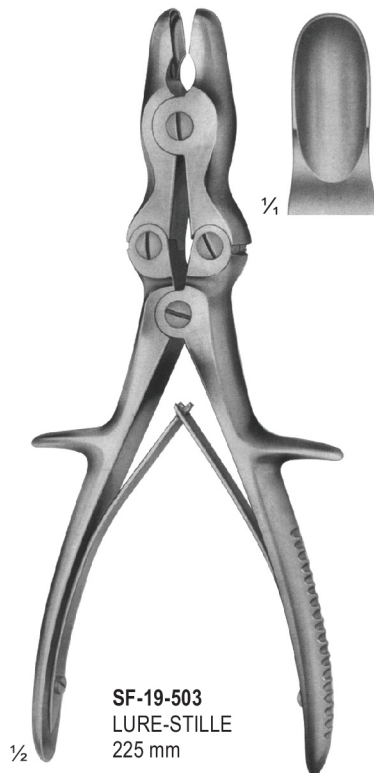
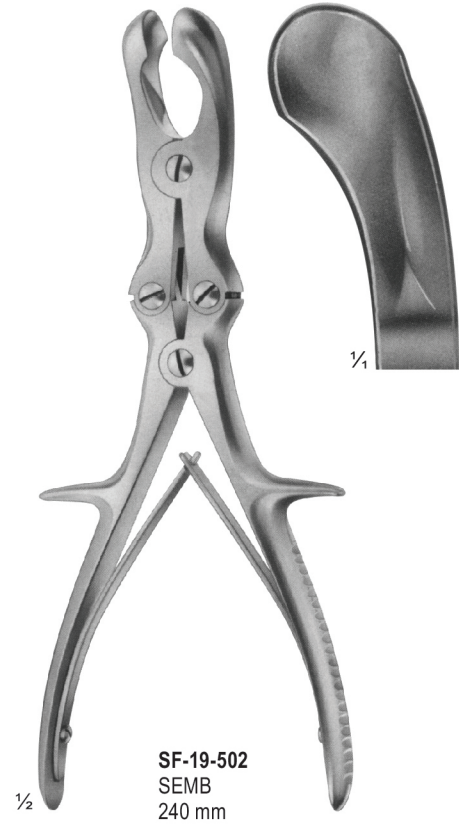
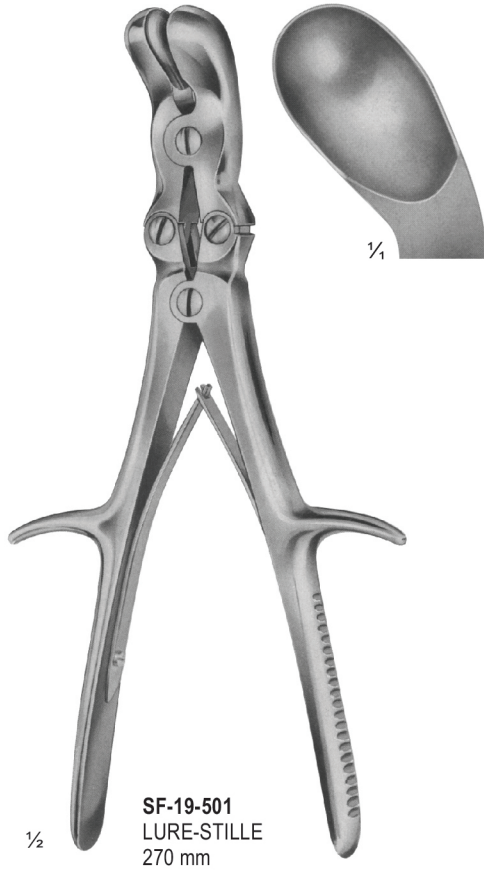

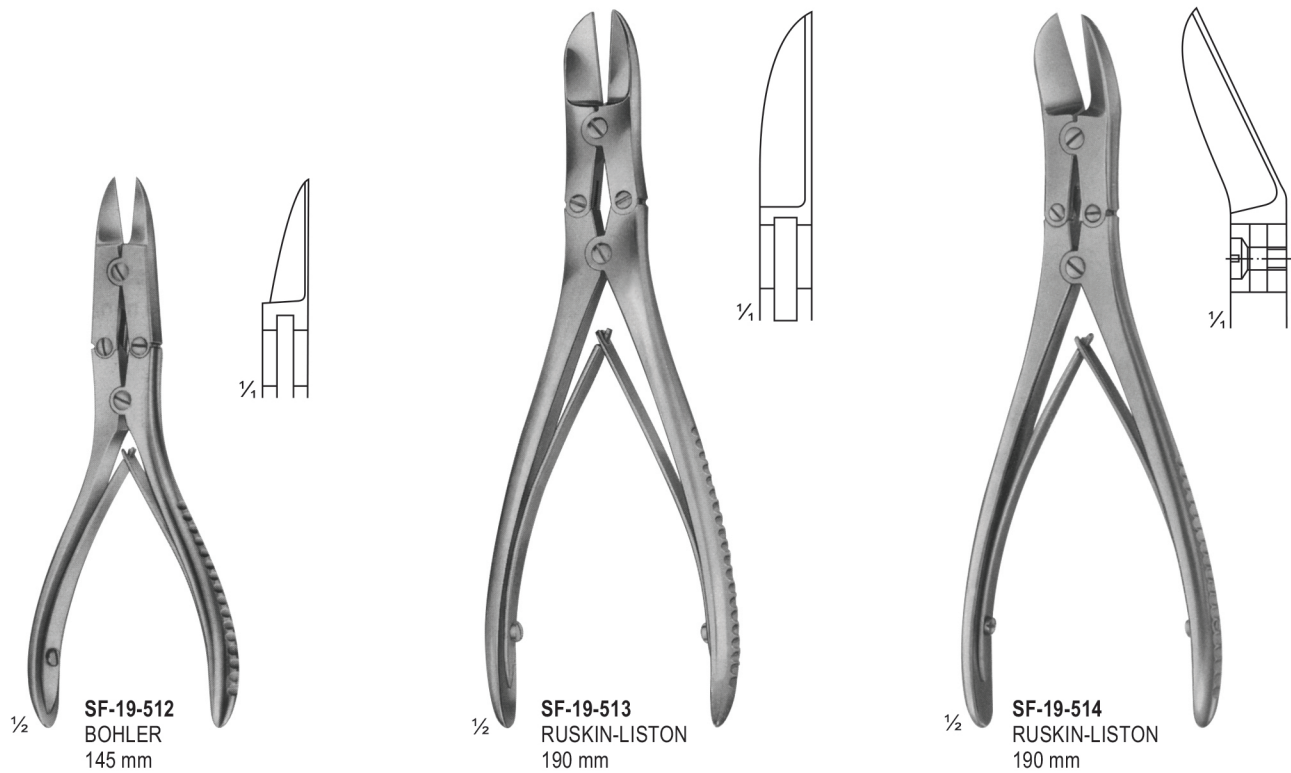
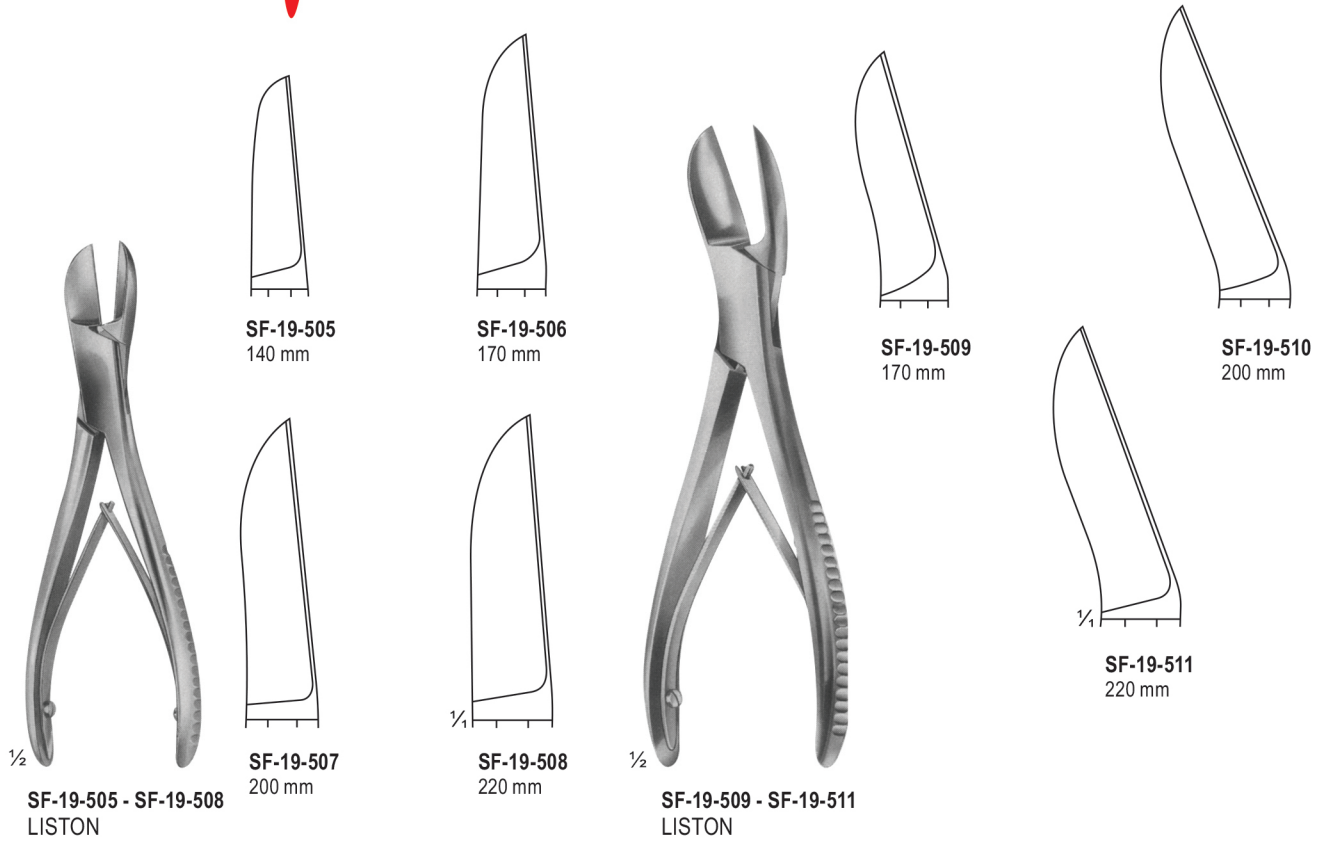

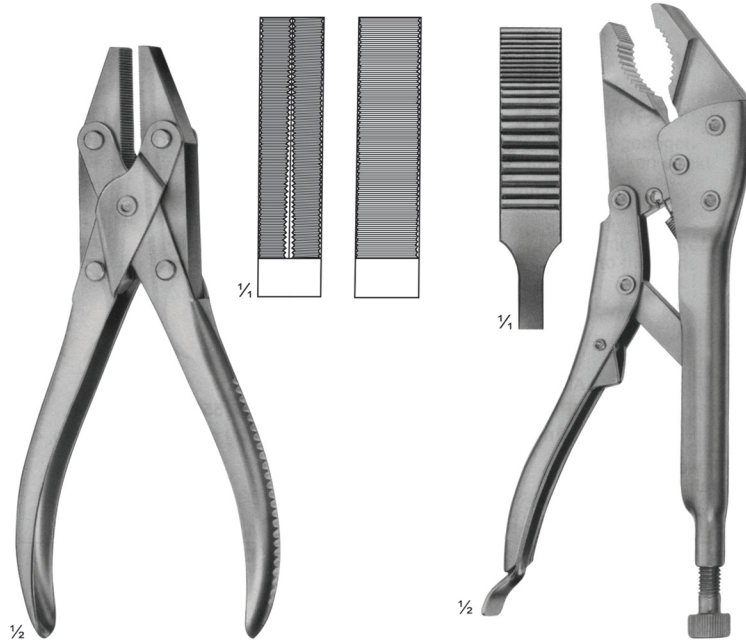

Flat-nosed pliers,
parallel
SF-19-530
185 mm

Vise grip
SF-19-531
200 mm

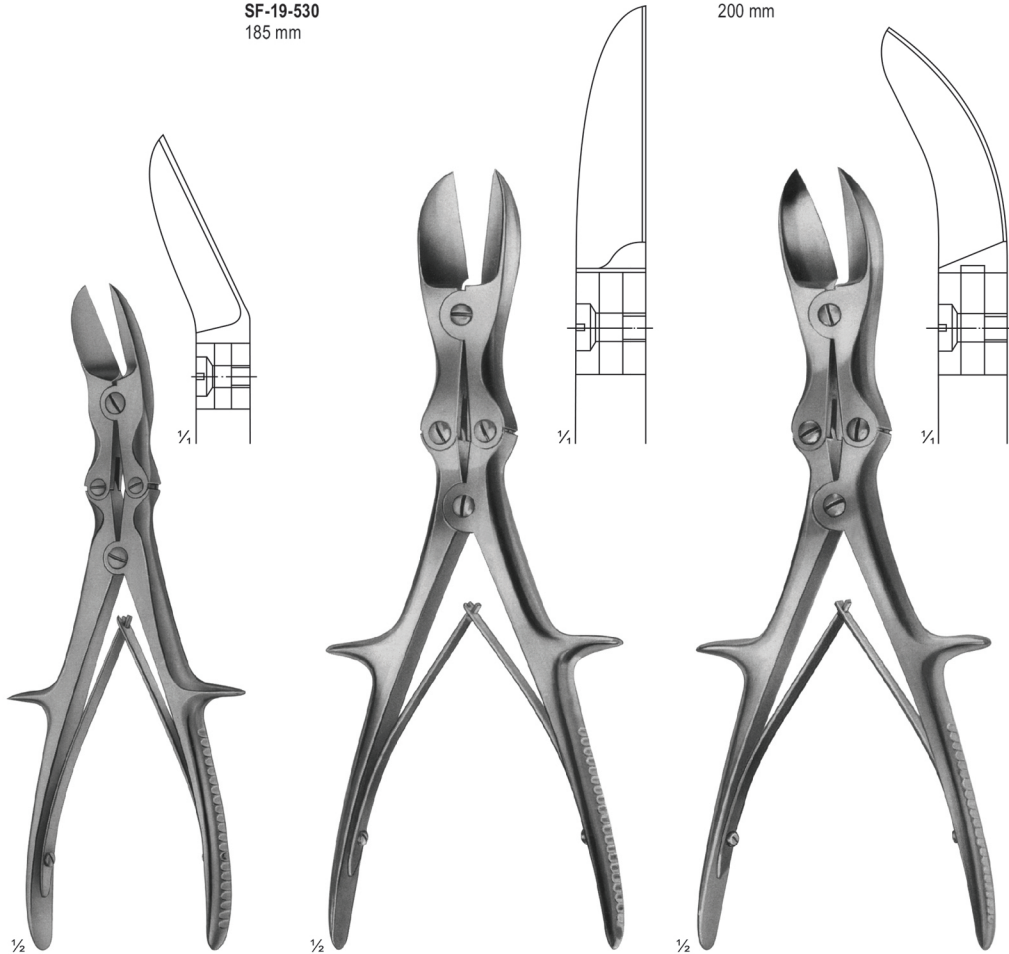

SF-19-515
LISTON
curved on flat
240 mm

SF-19-516
LISTON
straight
280 mm

SF-19-517
LISTON
curved on flat
280 mm



Durotip

SF-19-628
Cutter for cutting off
KIRSCHNER wires,
Tibia head screws,
bolts, pins, up to 6 mm diam.
47 cm



SF-19-629
For Soft Wire \varnothing cm 3.5
For Hars Wire \varnothing cm 2.5
22 cm



SF-19-630
For Soft Wire \varnothing cm 2.0
For Hars Wire \varnothing cm 1.5
22 cm



SF-19-631
For Soft Wire \varnothing cm 2.0
For Hars Wire \varnothing cm 1.6
18 cm



SF-19-632
17 cm



surgical screwdriver
3.5 / 4.5