



یارا مهر بذیان

ارائه کننده ابزار و ست های جراحی











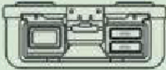

























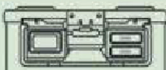



























کانتینر و سبد استریل

تلفن : ۰۲۱-۶۶۹۵۱۰۰۰

www.yaramehr.com

 Yaramehr.firm

1/2 Classic Model

| Specifications Sizes | Lid (Perforated) | Lid (Perforated) |
|---|--|--|
| | Box (Non-Perforated) | Box (Perforated) |
| 285 X 280 X 100 mm  | 10-500  10-501  10-502  10-503  10-504  10-505  | 10-530  10-531  10-532  10-533  10-534  10-535  |
| 285 X 280 X 135 mm  | 10-506  10-507  10-508  10-509  10-510  10-511  | 10-536  10-537  10-538  10-539  10-540  10-541  |
| 285 X 280 X 150 mm  | 10-512  10-513  10-514  10-515  10-516  10-517  | 10-542  10-543  10-544  10-545  10-546  10-547  |
| 285 X 280 X 200 mm  | 10-518  10-519  10-520  10-521  10-522  10-523  | 10-548  10-549  10-550  10-551  10-552  10-553  |
| 285 X 280 X 260 mm  | 10-524  10-525  10-526  10-527  10-528  10-529  | 10-554  10-555  10-556  10-557  10-558  10-559  |

Ps: All container measurements cover the outer size of the lids.



12-664
Security seal, made of plastic 100pcs.(Blue)



12-521 255 x 255 mm
SILICON MAT



12-740
Single use paper filter 100 pcs.



12-742
Teflon Filter
Number of sterilization cycle > 1200











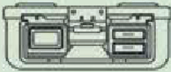











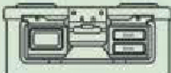











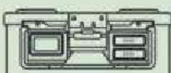







12-490 255 x 250 x 30 mm
12-491 255 x 250 x 50 mm
12-492 255 x 250 x 70 mm
12-493 255 x 250 x 100 mm
wire basket



GREY
YELLOW
GREEN
BLUE
RED
BLACK

3/4 Classic Model











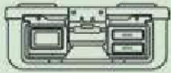











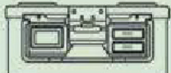











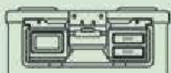











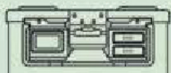















| Specifications Sizes | Lid (Perforated) | Lid (Perforated) |
|---|--|--|
| | Box (Non-Perforated) | Box (Perforated) |
| 465 X 280 X 100 mm  | 10-240  10-241  10-242  10-243  10-244  10-245  | 10-260  10-261  10-262  10-263  10-264  10-265  |
| 465 X 280 X 135 mm  | 10-246  10-247  10-248  10-249  10-250  10-251  | 10-266  10-267  10-268  10-269  10-270  10-271  |
| 465 X 280 X 150 mm  | 10-252  10-253  10-254  10-255  10-256  10-257  | 10-272  10-273  10-274  10-275  10-276  10-277  |
| Ps: All container measurements cover the outer size of the lids. |  |  |
| |  |  |



12-1500 405 x 250 x 30 mm
12-1501 405 x 250 x 50 mm
12-1502 405 x 250 x 70 mm
12-1503 405 x 250 x 100 mm
wire basket



1/1 Classic Model

| Specifications Sizes | Lid (Perforated) | Lid (Perforated) |
|---|--|--|
| | Box (Non-Perforated) | Box (Perforated) |
| 580 X 280 X 100 mm  | 10-010  10-011  10-012  10-013  10-014  10-015  | 10-040  10-041  10-042  10-043  10-044  10-045  |
| 580 X 280 X 135 mm  | 10-016  10-017  10-018  10-019  10-020  10-021  | 10-046  10-047  10-048  10-049  10-050  10-051  |
| 580 X 280 X 150 mm  | 10-022  10-023  10-024  10-025  10-026  10-027  | 10-052  10-053  10-054  10-055  10-056  10-057  |
| 580 X 280 X 200 mm  | 10-028  10-029  10-030  10-031  10-032  10-033  | 10-058  10-059  10-060  10-061  10-062  10-063  |
| 580 X 280 X 280 mm  | 10-034  10-035  10-036  10-037  10-038  10-039  | 10-064  10-065  10-066  10-067  10-068  10-069  |

Ps: All container measurements cover the outer size of the lids.

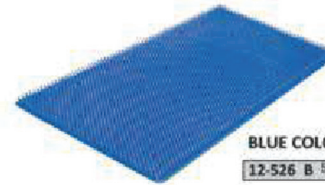

BLUE COLOURS
12-526 B 520 x 230 mm



12-740
Single use paper filter 100 pcs.



12-742
Teflon Filter
Number of sterilization cycle > 1200











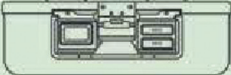



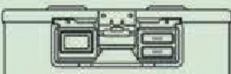

12-460 540 x 250 x 30 mm
12-461 540 x 250 x 50 mm
12-462 540 x 250 x 70 mm
12-463 540 x 250 x 100 mm
 wire basket



GREY
YELLOW
GREEN
BLUE
RED
BLACK

Special Size

| Specifications | Lid (Perforated) |
|---|---|
| | Box (Non-Perforated) |
| Sizes 350 x 250 x 100 mm  | 10-136  10-137  10-138  10-139  10-140  10-141  |
| 350 x 250 x 135 mm  | 10-142  10-143  10-144  10-145  10-146  10-147  |
|  | |



BLUE COLOURS

12-526 B 350 x 250 mm



12-761

Single use paper filter 100 pcs.
With indicator. No marking.



12-744

Teflon filter
Number of sterilization
cycle > 1200



12-462 330 x 230 x 70 mm

12-463 330 x 230 x 100 mm

wire basket





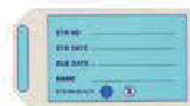





















































12-660
Security seal, made of
plastic 100pcs.(Red)



























































12-672
Labels, paper 100 pcs.
With indicator.
For full and half size containers

Dental Model & MINI Model









































| Specifications / Sizes | Lid (Perforated) | Lid (Perforated) | Lid (Non Perforated) |
|---|--|--|--|
| | Box (Non-Perforated) | Box (Perforated) | Box (Non-Perforated) |
| 320 X 190 X 50 mm  | 10-1800  10-1801  10-1802  10-1803  10-1804  10-1805  | 10-1820  10-1821  10-1822  10-1823  10-1824  10-1825  | 10-1840  10-1841  10-1842  10-1843  10-1844  10-1845  |
| 320 X 190 X 65 mm  | 10-1806  10-1807  10-1808  10-1809  10-1810  10-1811  | 10-1826  10-1827  10-1828  10-1829  10-1830  10-1831  | 10-1846  10-1847  10-1848  10-1849  10-1850  10-1851  |
| 320 X 190 X 130 mm  | 10-1812  10-1813  10-1814  10-1815  10-1816  10-1817  | 10-1832  10-1833  10-1834  10-1835  10-1836  10-1837  | 10-1852  10-1853  10-1854  10-1855  10-1856  10-1857  |





























| Specifications / Sizes | Lid (Perforated) | Lid (Perforated) | Lid (Non Perforated) |
|---|--|--|--|
| | Box (Non-Perforated) | Box (Perforated) | Box (Non-Perforated) |
| 315 X 135 X 40 mm  | 10-1900  10-1901  10-1902  10-1903  10-1904  10-1905  | 10-1920  10-1921  10-1922  10-1923  10-1924  10-1925  | 10-1940  10-1941  10-1942  10-1943  10-1944  10-1945  |
| 315 X 135 X 70 mm  | 10-1906  10-1907  10-1908  10-1909  10-1910  10-1911  | 10-1926  10-1927  10-1928  10-1929  10-1930  10-1931  | 10-1946  10-1947  10-1948  10-1949  10-1950  10-1951  |
| 315 X 135 X 100 mm  | 10-1912  10-1913  10-1914  10-1915  10-1916  10-1917  | 10-1932  10-1933  10-1934  10-1935  10-1936  10-1937  | 10-1952  10-1953  10-1954  10-1955  10-1956  10-1957  |



IMPLANT Model

| Specifications / Sizes | Lid (Perforated) | Lid (Perforated) | Lid (Non Perforated) | NON FILTER |
|---|---|---|---|---|
| | Box (Non-Perforated) | Box (Perforated) | Box (Non-Perforated) | |
| 300 X 149 X 65 mm  | 09-010  09-011  09-012  09-013  09-014  09-015  | 09-022  09-023  09-024  09-025  09-026  09-027  | 09-034  09-035  09-036  09-037  09-038  09-039  |  |
| 500 X 169 X 75 mm  | 09-016  09-017  09-018  09-019  09-020  09-021  | 09-028  09-029  09-030  09-031  09-032  09-033  | 09-040  09-041  09-042  09-043  09-044  09-045  |  |

SCOPY Model

| Specifications / Sizes | Lid (Perforated) | Lid (Perforated) |
|---|--|--|
| | Box (Non-Perforated) | Box (Perforated) |
| 250 X 60 X 50 mm  | 09-100  09-101  09-102  09-103  09-104  09-105  | 09-115  09-116  09-117  09-118  09-119  09-120  |
| 450 X 70 X 70 mm  | 09-106  09-107  09-108  09-109  09-110  09-111  | 09-121  09-122  09-123  09-124  09-125  09-126  |



13-1062 640 x 150 x 77 mm
Endoscope basket



13-1050 670 x 80 x 52 mm
13-1051 460 x 80 x 52 mm
13-1052 290 x 80 x 52 mm
Endoscope basket

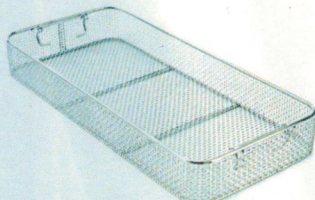
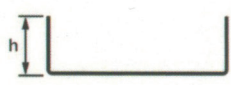

Wire Baskets

h = 50 , 70 , 100 mm
Size : 540x250 mm

Washing Baskets



h = 50 mm
Size : 480x250 mm

Wire Baskets

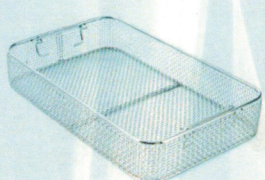
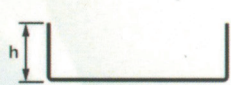

h = 50 , 70 , 100 mm
Size : 405x250 mm

Dental Basket



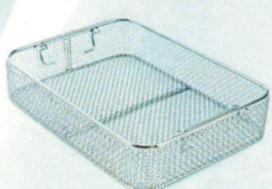

h = 45 mm
Size : 270x170 mm

Wire Baskets

h = 50 , 70 , 100 mm
Size : 300x220 mm

Mini Basket

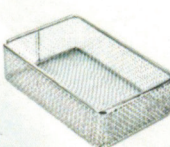
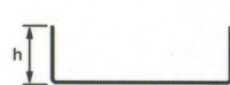
h = 45 mm
Size : 270x140 mm

Wire Baskets

h = 50 , 70 , 100 mm
Size : 255x250 mm

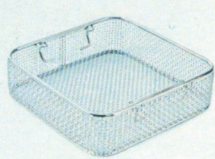
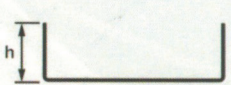
Endoscope Basket



h = 52 mm
Size : 670x80 mm