



یارا مهر بنیان

ارائه کننده ابزار و ست های جراحی

کاتالوگ مغز و اعصاب و ستون فقرات

تلفن : ۰۲۱-۶۶۹۵۱۰۰۰

www.yaramehr.com

 Yaramehr.firm

130°

upwards cutting

140 mm

SF-06-105
1 mm



SF-06-106
2 mm



SF-06-107
3 mm



SF-06-108
4 mm



SF-06-109
5 mm



1/2

SF-06-105 - SF-06-109
KERRISON-JACOBY

90°

upwards cutting

180 mm

SF-06-110
1 mm



SF-06-111
2 mm



FERRIS-SMITH-KERRISON

SF-06-112
3 mm

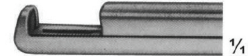

SF-06-113
4 mm



SF-06-114
5 mm



1/2

SF-06-110 - SF-06-114
KERRISON-JACOBY

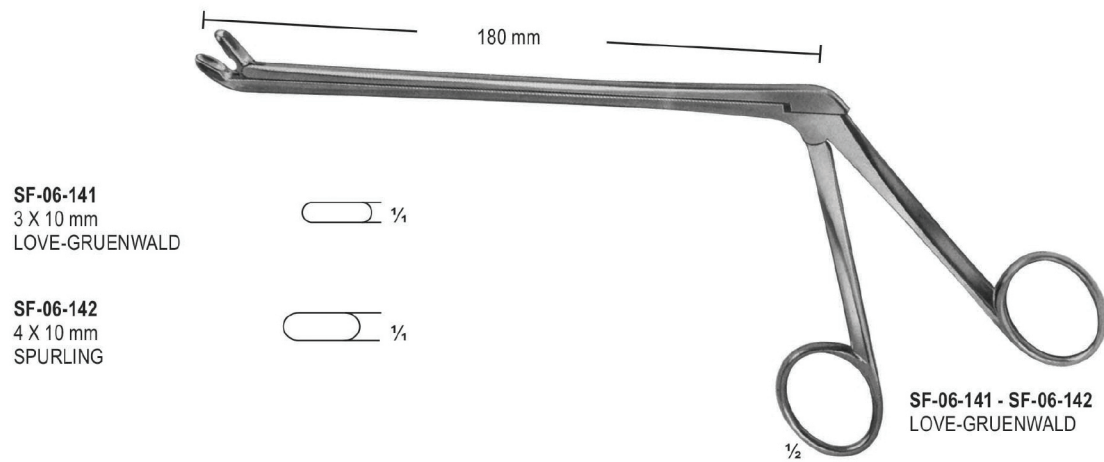
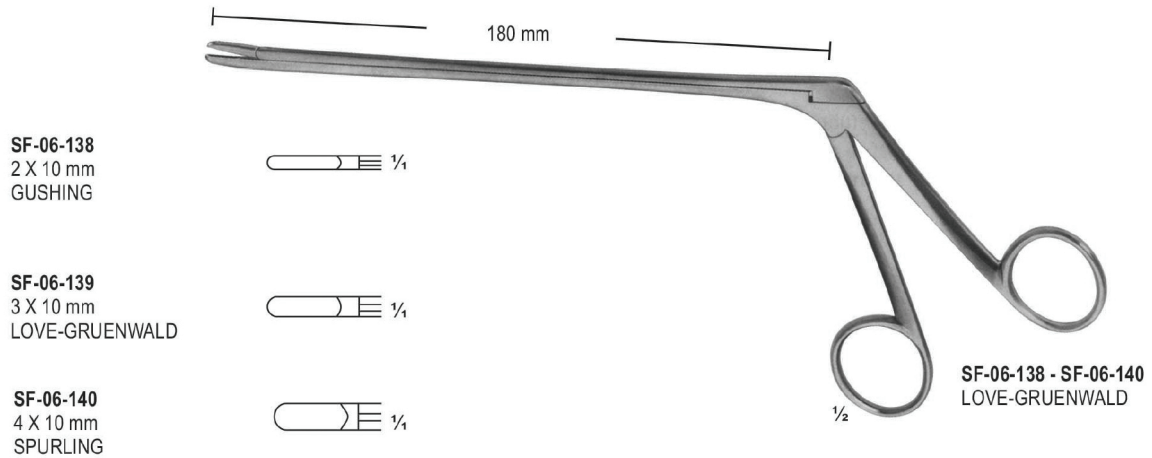
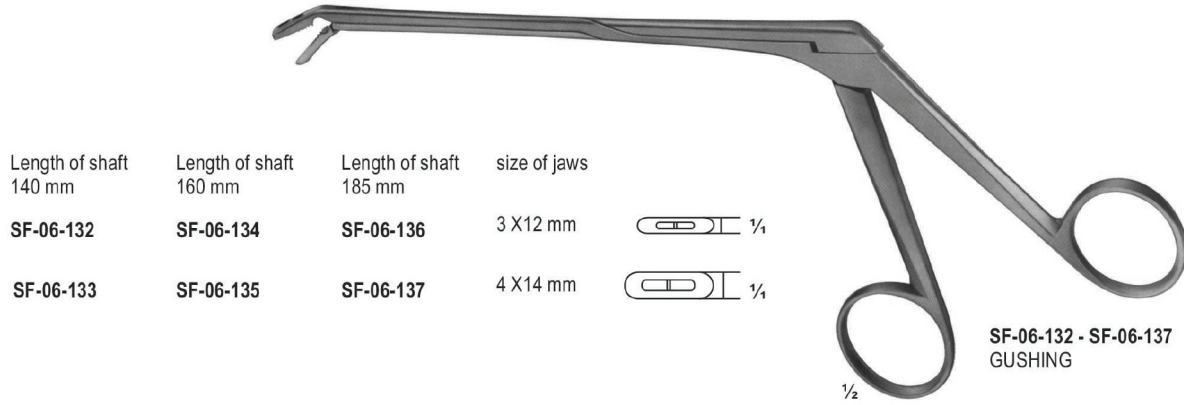

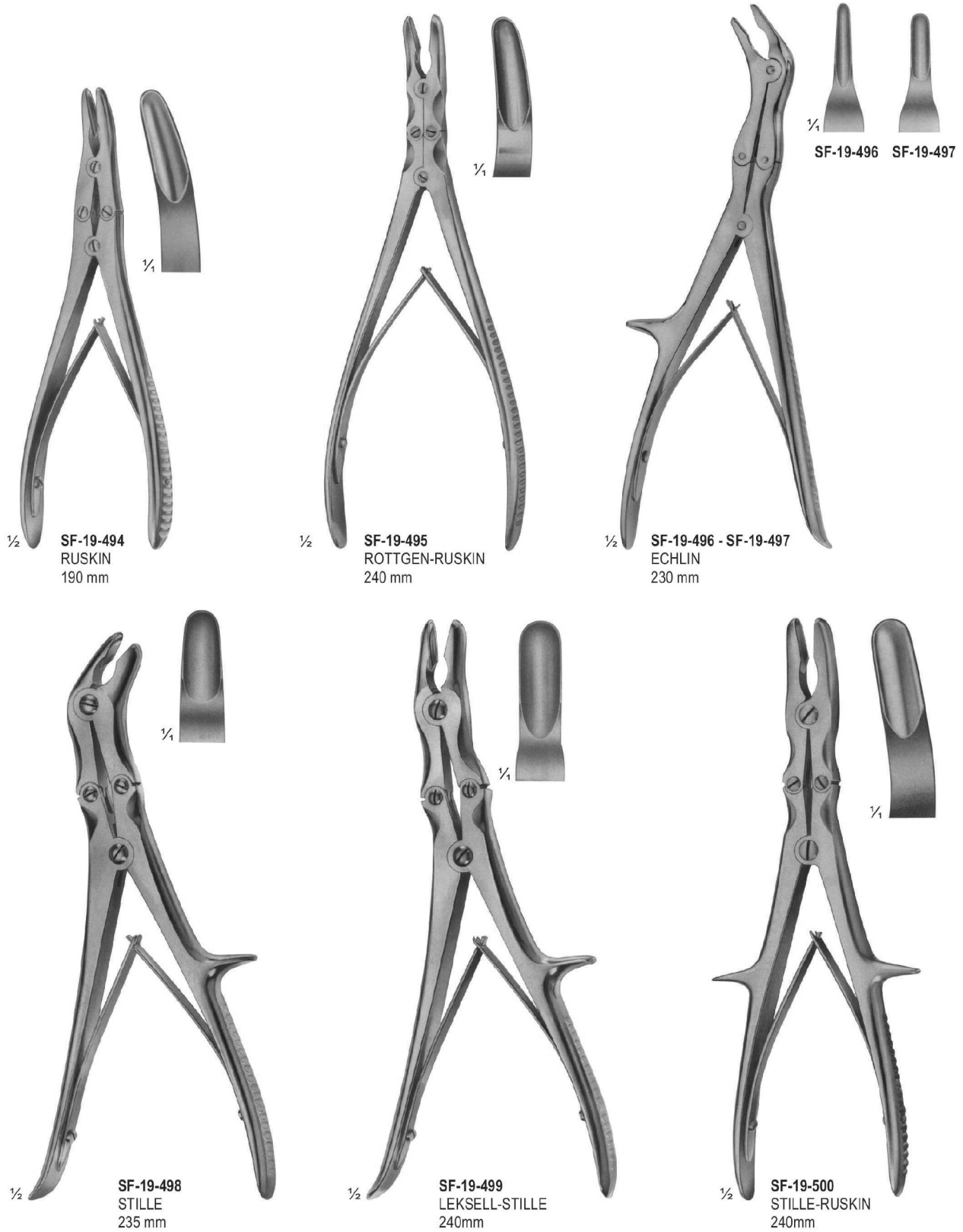

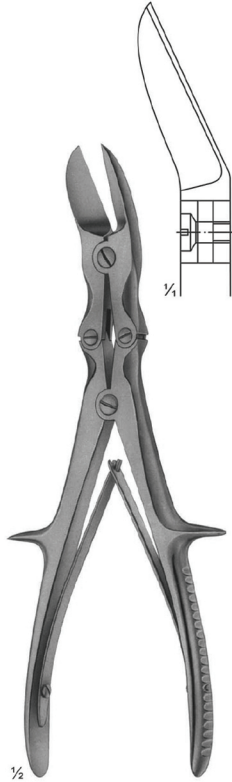

SF-19-515
LISTON
curved on flat
240 mm

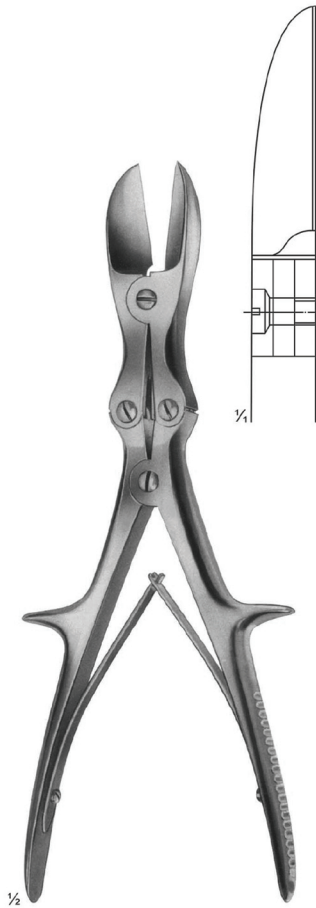

SF-19-516
LISTON
straight
280 mm

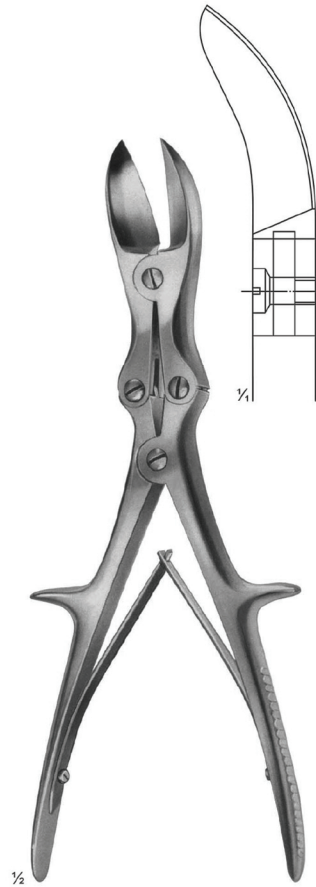

SF-19-517
LISTON
curved on flat
280 mm



BOHLER
SF-19-538
145 mm

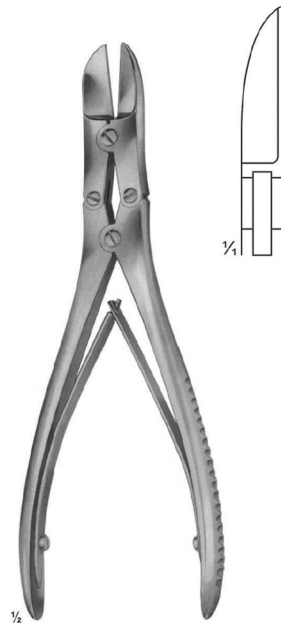

RUSKIN-LISTON
SF-19-539
190 mm



RUSKIN-LISTON
SF-19-540
190 mm

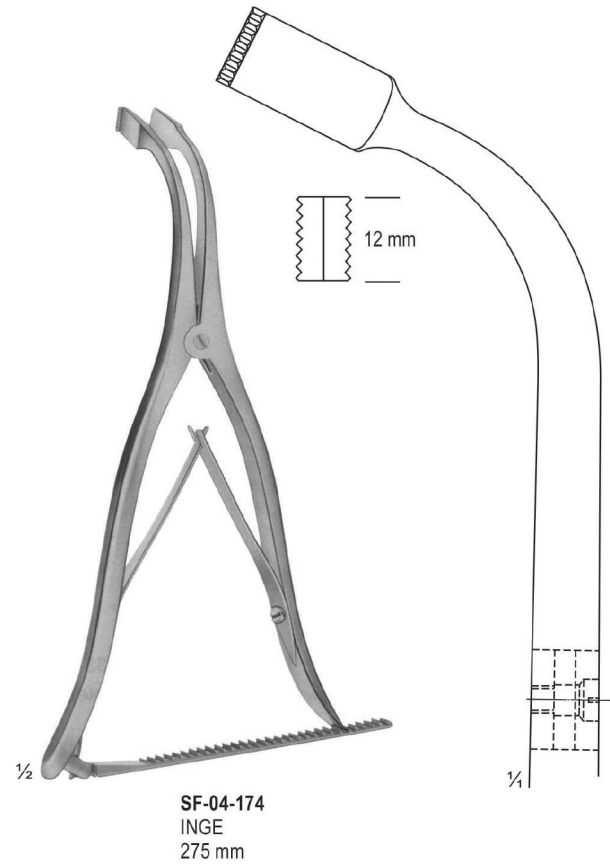
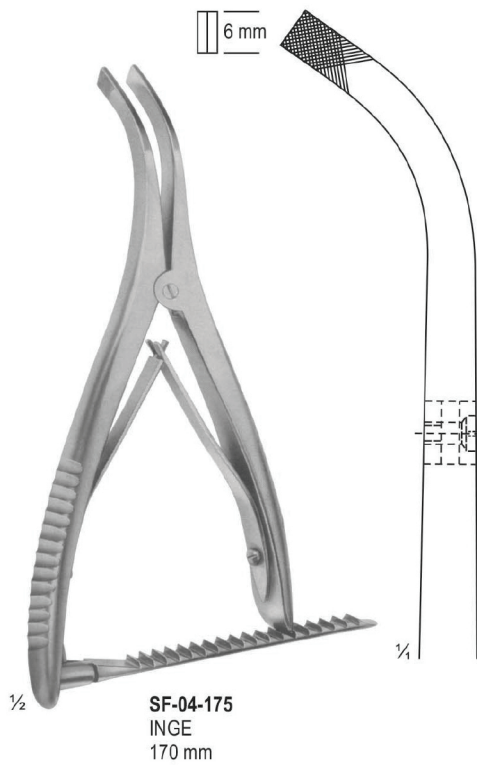
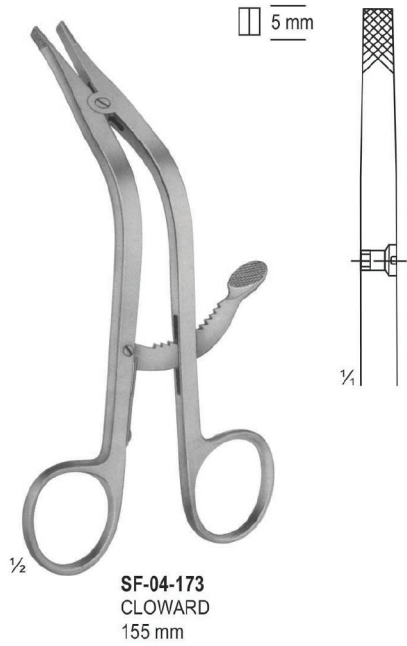



1/2

SF-06-187
Large Pattern
and Spare Pin



COBB
SF-19-225 - SF-19-227



SF-19-225
28 cm



SF-19-226
280 mm

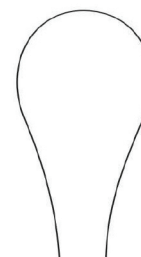

SF-19-227
280 mm



SF-04-204 - SF-04-208
SF-04-204 15 x 40 mm
SF-04-205 15 x 45 mm
SF-04-206 15 x 50 mm
SF-04-207 15 x 55 mm
SF-04-208 15 x 60 mm
serrated

SF-04-209 - SF-04-213
SF-04-209 15 x 40 mm
SF-04-210 15 x 45 mm
SF-04-211 15 x 50 mm
SF-04-212 15 x 55 mm
SF-04-213 15 x 60 mm
Blunt



CONE
SF-04-214 - SF-04-221
SF-04-214 14 cm, 18 mm 3 x 4
SF-04-215 16 cm, 18 mm 3 x 4
SF-04-216 20 cm, 20 mm 3 x 4
SF-04-217 24 cm, 27 mm 3 x 4
SF-04-218 14 cm, 18 mm 3 x 4
SF-04-219 16 cm, 18 mm 3 x 4
SF-04-220 20 cm, 20 mm 3 x 4
SF-04-221 24 cm, 27 mm 3 x 4
prongs blunt

CLOWARD-TYPE
SF-04-203
25.5 cm
with ball snap closure Cervical Retractor
complete consisting of Retractor Body
25.5 cm, 110 mm spread (without blades)



MARKHAM-MEYERDING
SF-04-222
18 cm, 50 x 25 mm left
Hemilaminectomy Retractor



MARKHAM-MEYERDING
SF-04-223
18 cm, 50 x 25 mm right
Hemilaminectomy Retractor

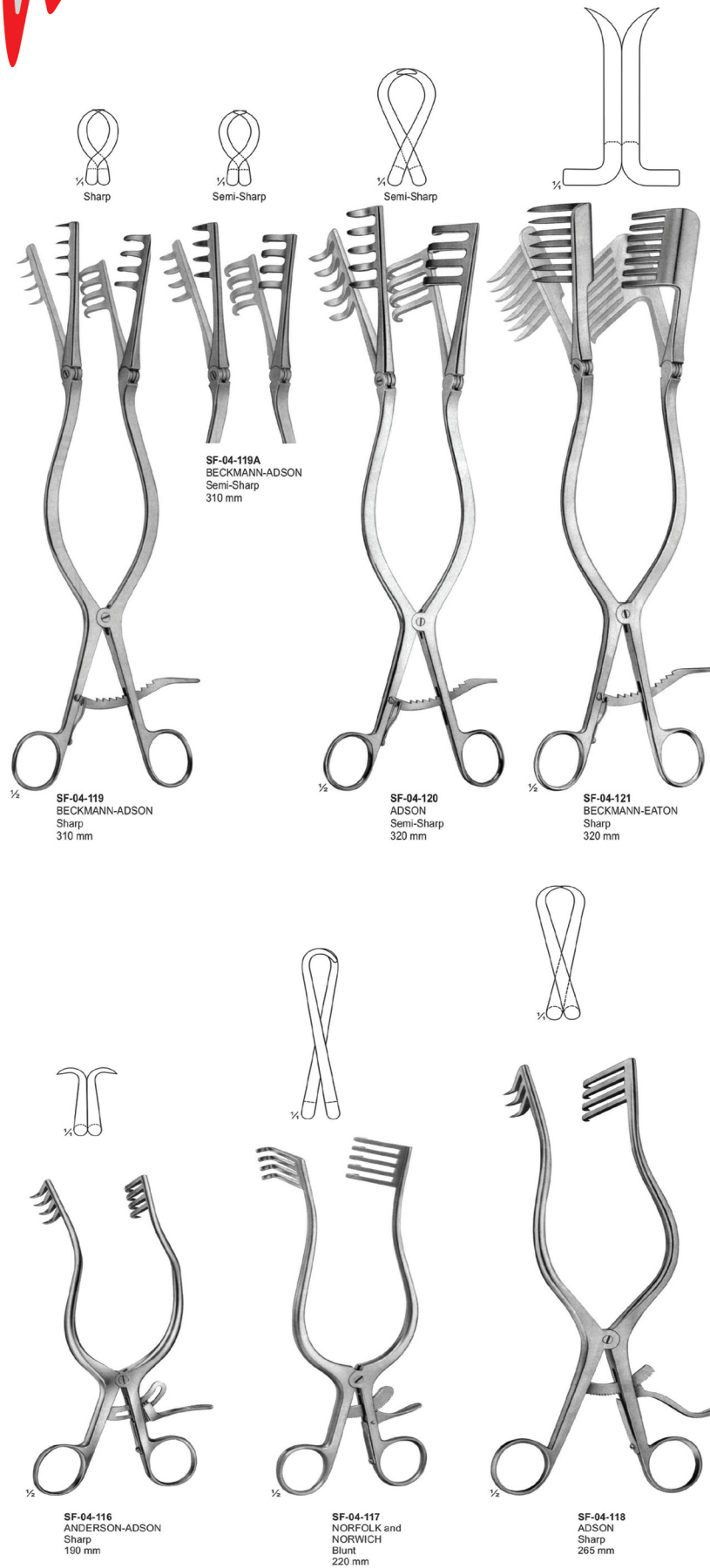

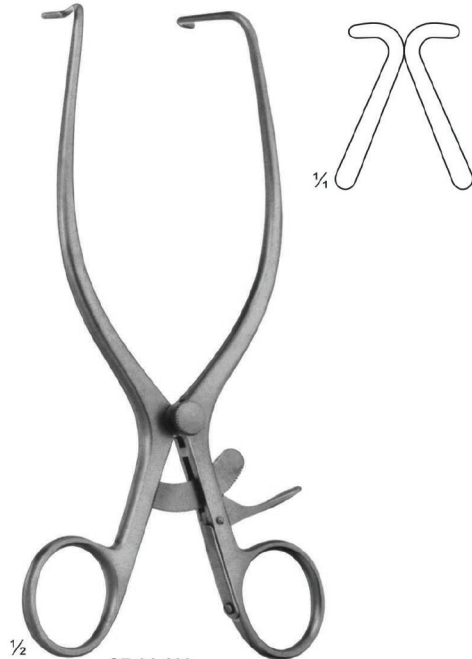

SF-04-122
JACKSON BURROWS
Retractor, blunt
185 mm



SF-04-123
GELPI
Vaginal Retractor
135 mm



SF-04-124
GELPI
Skin- and Vaginal Retractor
175 mm



SF-04-125
DE BAKEY
Femur Retractor
145 mm



CASPAR
SF-21-338
Transverse Retractor double-hinged
quick connect 72 mm spread, side-loading



CASPAR
SF-21-339
Longitudinal Retractor double-hinged,
ring handle, quick connect
185 mm
75 mm spread, side-loading



CASPAR
SF-21-340
Specula Retractor single-hinged,
quick connect
115 mm
70 mm spread, side-loading



CASPAR
SF-21-341
Quick Connect Blade
Positioner Handle
210 mm
for quick connect
blades only



SF-21-342 - SF-21-346
SF-21-342 23 x 40 mm
SF-21-343 23 x 45 mm
SF-21-344 23 x 50 mm
SF-21-345 23 x 55 mm
SF-21-346 23 x 60 mm
Medial Toothed Blades
Stainless Steel
quick connect



SF-21-347 - SF-21-351
SF-21-347 23 x 40 mm
SF-21-348 23 x 45 mm
SF-21-349 23 x 50 mm
SF-21-350 23 x 55 mm
SF-21-351 23 x 60 mm
Lateral Serrated Blades
Stainless Steel
quick connect



SF-21-352 - SF-21-356
SF-21-352 23 x 45 mm
SF-21-353 23 x 50 mm
SF-21-354 23 x 55 mm
SF-21-355 23 x 60 mm
SF-21-356 23 x 65 mm
Blunt Blades
Stainless Steel
quick connect



SF-21-357 - SF-21-361
SF-21-357 23 x 40 mm
SF-21-358 23 x 45 mm
SF-21-359 23 x 50 mm
SF-21-360 23 x 55 mm
SF-21-361 23 x 60 mm
Medial Toothed Blades
Titanium
quick connect



SF-21-362 - SF-21-366
SF-21-362 23 x 40 mm
SF-21-363 23 x 45 mm
SF-21-364 23 x 50 mm
SF-21-365 23 x 55 mm
SF-21-366 23 x 60 mm
Lateral Serrated Blades
Titanium
quick connect



SF-21-367 - SF-21-371
SF-21-367 23 x 45 mm
SF-21-368 23 x 50 mm
SF-21-369 23 x 55 mm
SF-21-370 23 x 60 mm
SF-21-371 23 x 65 mm
Blunt Blades
Titanium
quick connect

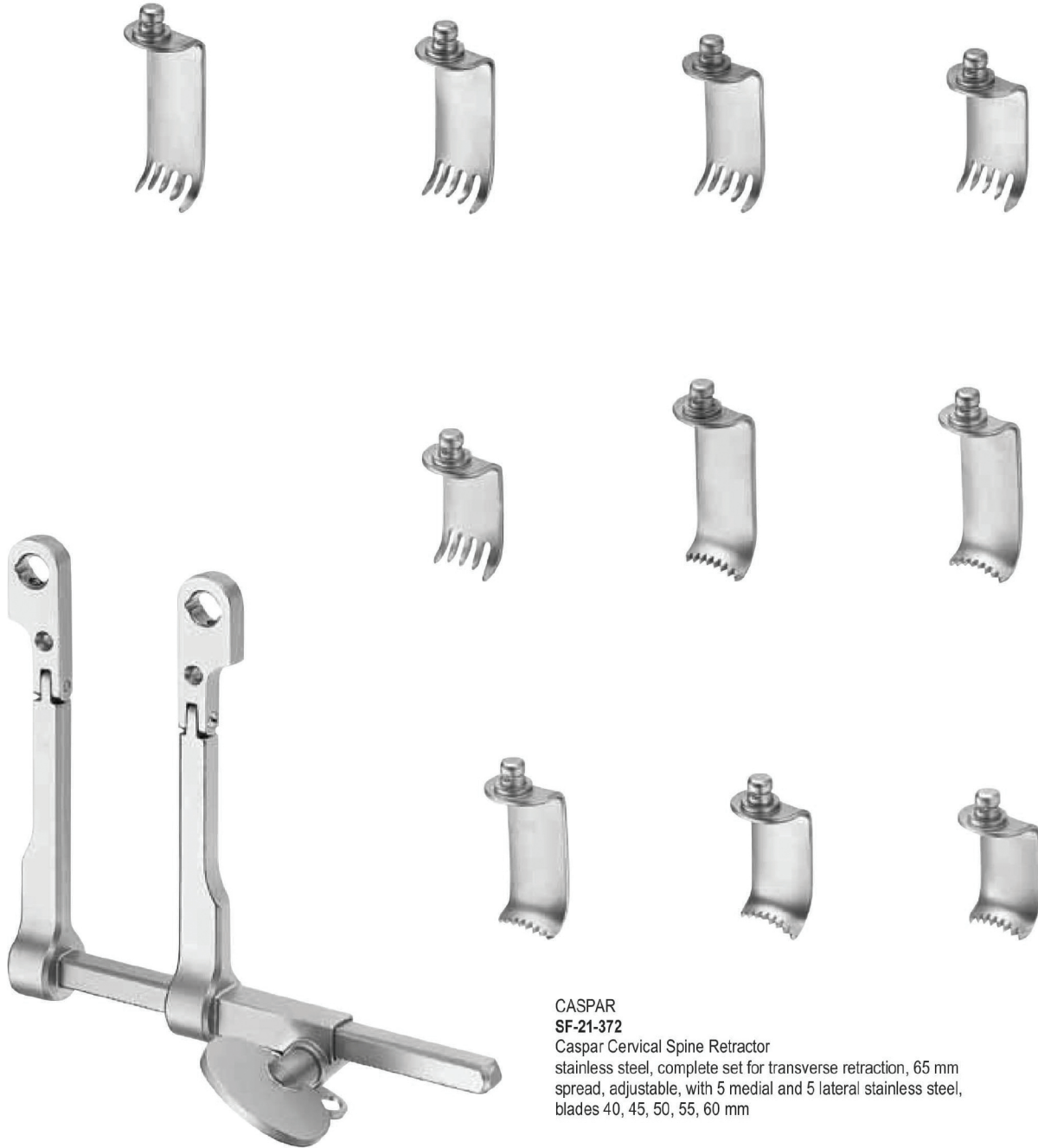

**CASPAR
SF-21-372**
Caspar Cervical Spine Retractor
stainless steel, complete set for transverse retraction, 65 mm
spread, adjustable, with 5 medial and 5 lateral stainless steel,
blades 40, 45, 50, 55, 60 mm

SF-21-373
TI Caspar Cervical Spine Retractor
titanium, complete set for transverse retraction, 65 mm
spread, adjustable, with 5 medial and 5 lateral titanium
blades 40, 45, 50, 55, 60 mm



CASPAR
SF-21-374
Caspar Microdiscectomy Retractor
for microsurgical treatment of
herniated lumbar discs
45 mm spread



SF-21-375 - SF-21-383
SF-21-375 35 mm
SF-21-376 40 mm
SF-21-377 45 mm
SF-21-378 50 mm
SF-21-379 55 mm
SF-21-380 60 mm
SF-21-381 65 mm
SF-21-382 75 mm
SF-21-383 85 mm
Lateral Blades



SF-21-384 - SF-21-390
SF-21-384 40 mm
SF-21-385 45 mm
SF-21-386 50 mm
SF-21-387 55 mm
SF-21-388 60 mm
SF-21-389 65 mm
SF-21-390 70 mm
Paraspina Blades



CASPAR
SF-21-391 - SF-21-400
SF-21-391 40 mm
SF-21-392 45 mm
SF-21-393 50 mm
SF-21-394 55 mm
SF-21-395 60 mm
SF-21-396 65 mm
SF-21-397 70 mm
SF-21-398 75 mm
SF-21-399 80 mm
SF-21-400 85 mm
Lumbar Speculum
fenestrated



CASPAR
SF-21-472

Distractor only for use in surgical procedures from the left approach the right approach for the upper cervical spine Distractor as above but with elongated toothed bar for multilevel (more than 2) distraction

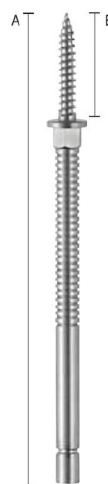

DISTRACTION PIN A/B
SF-21-473 - SF-21-476
SF-21-473 66/12 mm
SF-21-474 68/14 mm
SF-21-475 70/16 mm
SF-21-476 72/18 mm



TWIST DRILL
SF-21-477



DRILL GUIDE
SF-21-478



SCREW DRIVER
SF-21-479

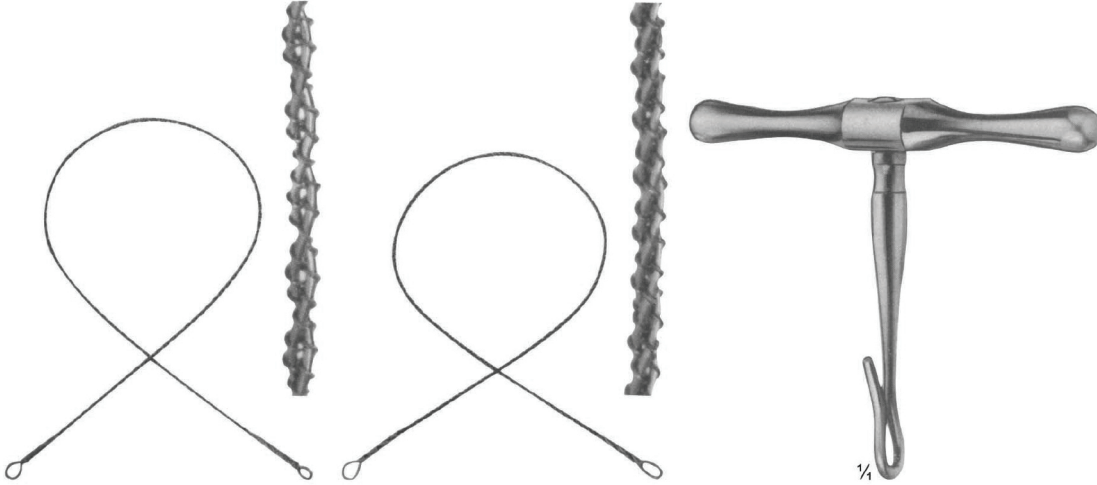

OLIVECRONA
SF-06-175 300 mm
SF-06-176 400 mm
SF-06-177 500 mm
SF-06-178 700 mm

GIGLI
SF-06-179 300 mm
SF-06-180 400 mm
SF-06-181 500 mm
fine, 6 wires twisted
SF-06-182
coars, 4 wires twisted

SF-06-183
GIGLI
Handle



LEYLA
SF-21-165
Self-Retaining brain retractor
with 2 arms complete

LEYLABED RETRACTOR
SF-21-166
Self-Retaining brain retractor
bed retractor not illustrated



SF-21-101



SF-21-102



SF-21-103



SF-21-104

WAGENER
SF-21-101 - SF-21-104
150 mm



SF-21-105



SF-21-106



SF-21-107

GRAEFE
SF-21-105 - SF-21-107
140 mm



1/4

BROM
SF-21-108
Vein hook
170 mm



1/4

CRILE
SF-21-109
200 mm



1/2

CUSHING
SF-21-110- SF-21-111
190 mm



SF-21-110



SF-21-111



SF-11-256
3.6 mm
Fig: 000

SF-11-257
4.4 mm
Fig: 00

SF-11-258
5.2 mm
Fig: 0

SF-11-259
6.8 mm
Fig: 1

SF-11-256 - SF-11-259
250 mm



SF-11-260
3.6 mm
Fig: 000

SF-11-261
4.4 mm
Fig: 00

SF-11-262
5.2 mm
Fig: 0

SF-11-263
6.8 mm
Fig: 1

SF-11-260 - SF-11-263
250 mm



SF-11-264
3 mm

SF-11-265
4 mm

SF-11-266
5 mm

SF-11-264 - SF-11-266
BUSHE
250 mm



HESS
Nerve Root Retractor
SF-21-152 - SF-21-154
SF-21-152 175 mm 3 mm
SF-21-153 175 mm 5 mm
SF-21-154 175 mm 7 mm



LOVE
Nerve Root Retractor
SF-21-155 - SF-21-157
SF-21-155 190 mm 30°
SF-21-156 190 mm 45°
SF-21-157 190 mm 90°



CASPAR
Nerve Root Retractor
SF-21-158 - SF-21-160
SF-21-158 245 mm 6 mm
SF-21-159 245 mm 8 mm
SF-21-160 245 mm 10 mm



LOVE
SF-21-161
210 mm

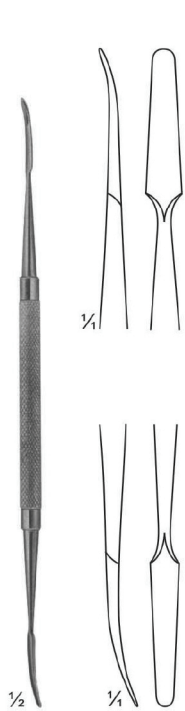

SF-11-149
KILLIAN
sharp/blunt
185 mm

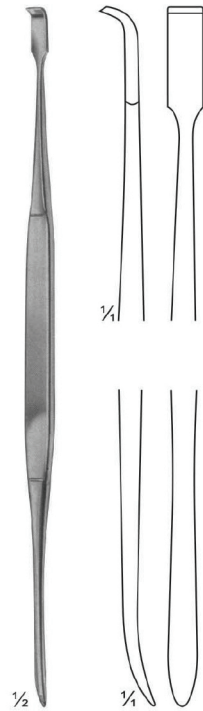

SF-11-150
HOWARTH
sharp/blunt
215 mm

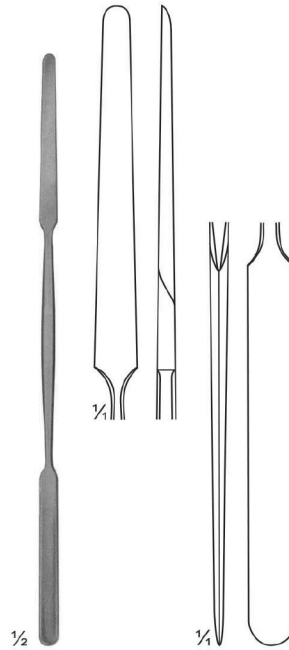

SF-11-151
KILLIAN
sharp/blunt
185 mm

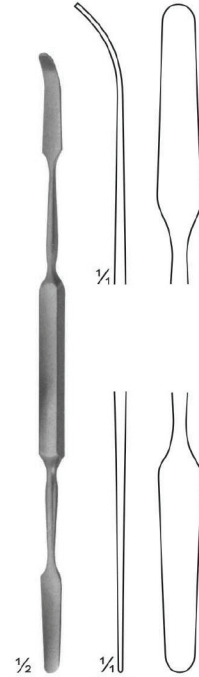

SF-11-152
MAC DONALD
blunt/blunt
185 mm

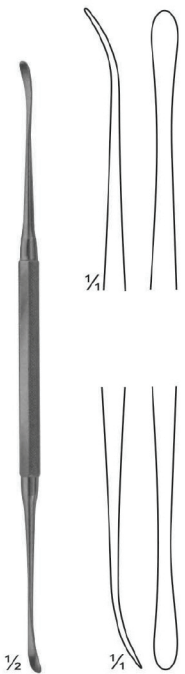

SF-11-153
FREER
sharp/blunt
185 mm

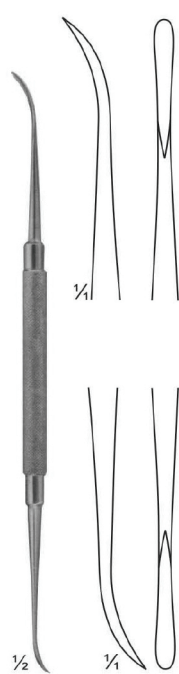

SF-11-154
FREER-YASARGIL
sharp/sharp
185 mm

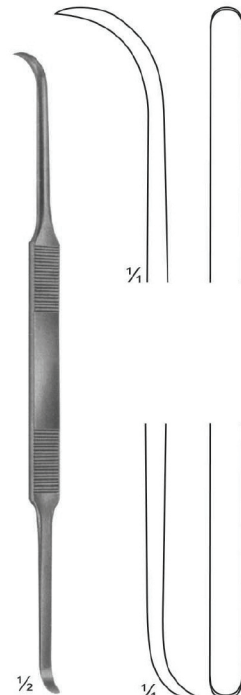

SF-11-155
COTTLE
sharp/sharp
200 mm

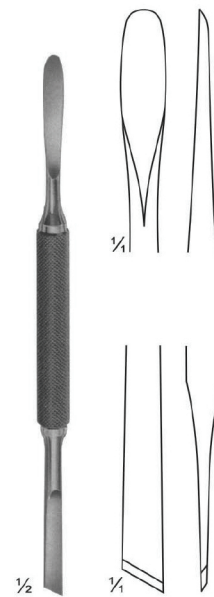

SF-11-156
MEAD
sharp/sharp
165 mm

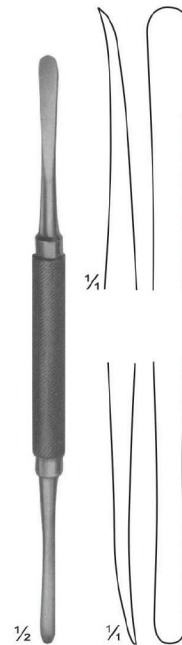

SF-11-157
MOLT
sharp/sharp
180 mm

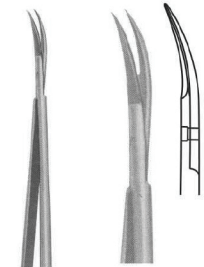

1/2
SF-23-122
YASARGIL
245 mm

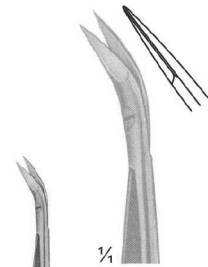

1/4
SF-23-123

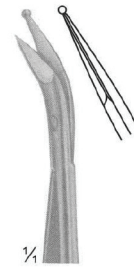

1/4
SF-23-124



1/2
SF-23-123 - SF-23-124
Laterally Angled
200 mm

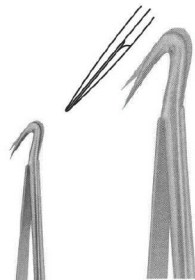

1/2
SF-23-125
Laterally Angled
190 mm

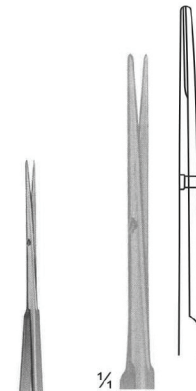

1/4
SF-23-126

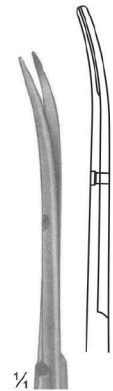

1/4
SF-23-127



1/2
SF-23-126 - SF-23-127
YASARGIL
225 mm

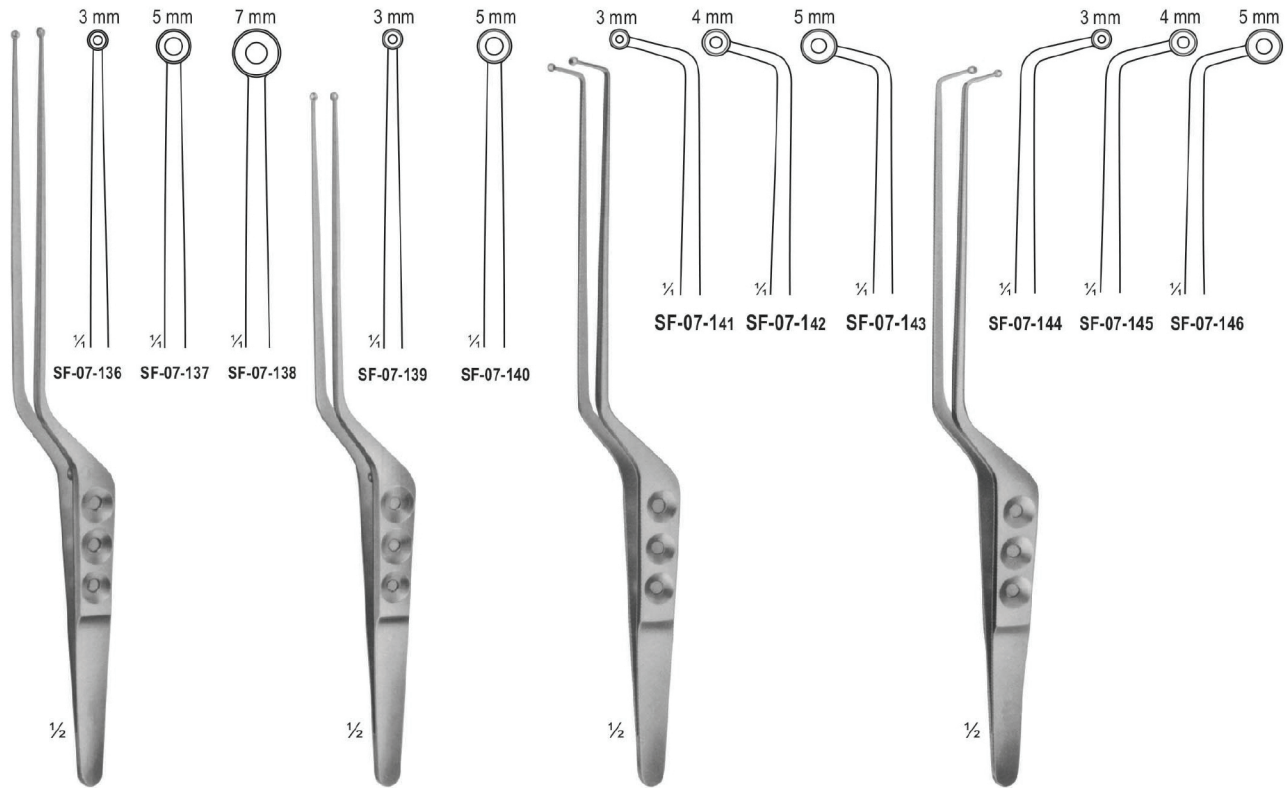

SF-07-136 - SF-07-138
YASARGIL-SAMI
Jaws Spoon-Shaped
240 mm

SF-07-139 - SF-07-140
YASARGIL
Jaws Spoon-Shaped
220 mm

SF-07-141 - CD-043
SAMII
Jaws Spoon-Shaped
230 mm

SF-07-144 - SF-07-146
SAMII
Jaws Spoon-Shaped
230 mm

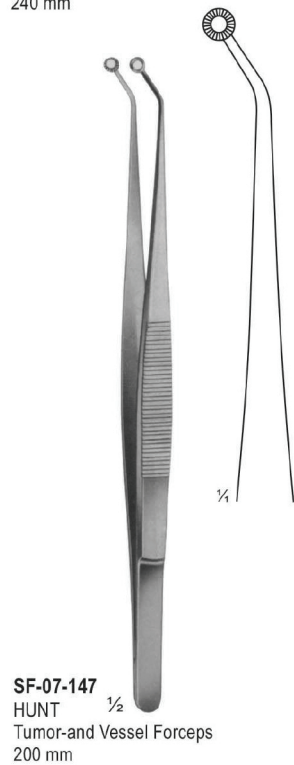

SF-07-147
HUNT $\frac{1}{2}$
Tumor and Vessel Forceps
200 mm

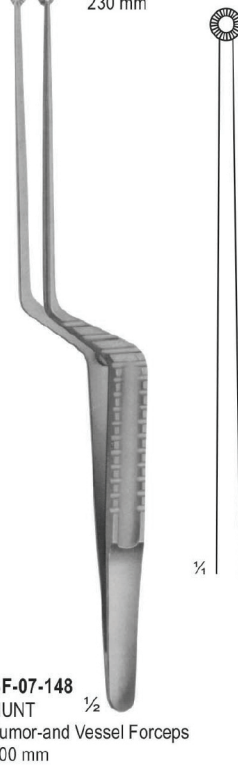

SF-07-148
HUNT $\frac{1}{2}$
Tumor and Vessel Forceps
200 mm

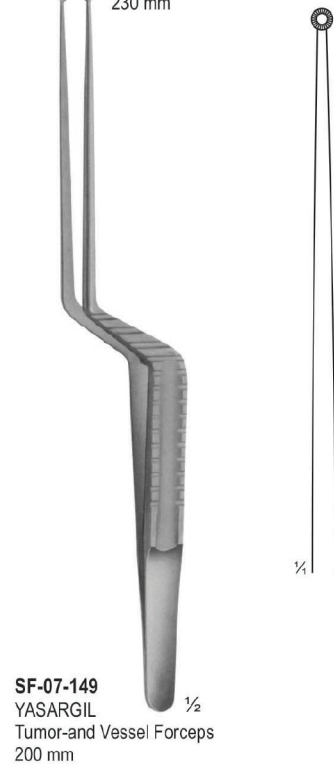

SF-07-149
YASARGIL $\frac{1}{2}$
Tumor and Vessel Forceps
200 mm

MICRO NEEDLE HOLDERS

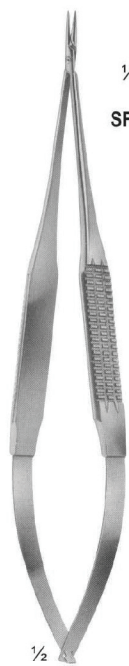

SF-23-279 SF-23-280

SF-23-279 - SF-23-280
Without catch
185 mm



SF-23-281 Without catch
SF-23-282 With catch

SF-23-281 - SF-23-282
JACOBSON
185 mm



SF-23-283
Without catch
195 mm



SF-23-284 SF-23-285

SF-23-284 - SF-23-285
YASARGIL
With catch
200 mm